

electronics

radio, communication, industrial applications of electron tubes... engineering and manufacture

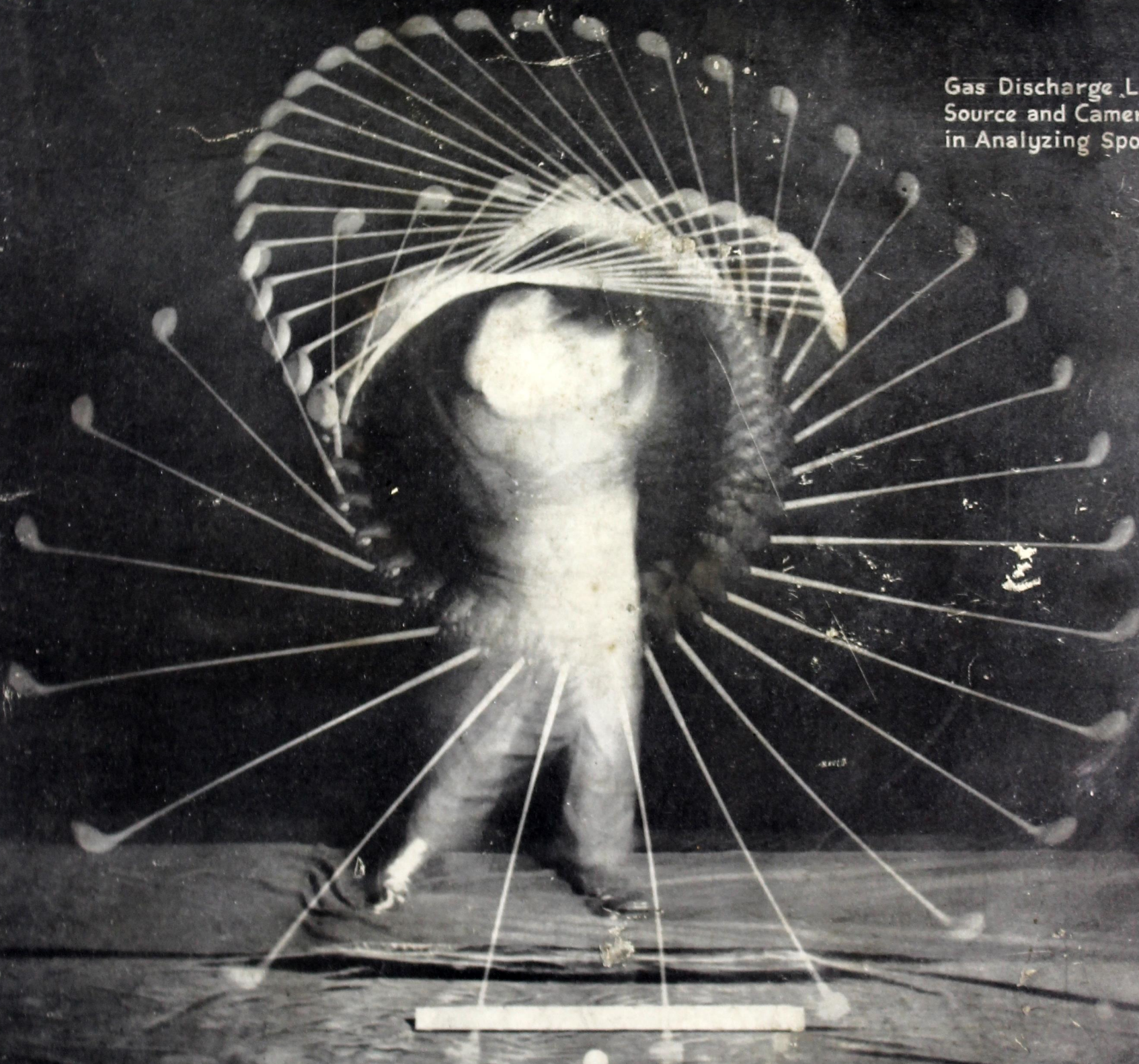

Gas Discharge Light
Source and Camera Aid
in Analyzing Sports



McGRAW-HILL
PUBLISHING COMPANY, INC.

FEBRUARY
1939

Price 50 Cents

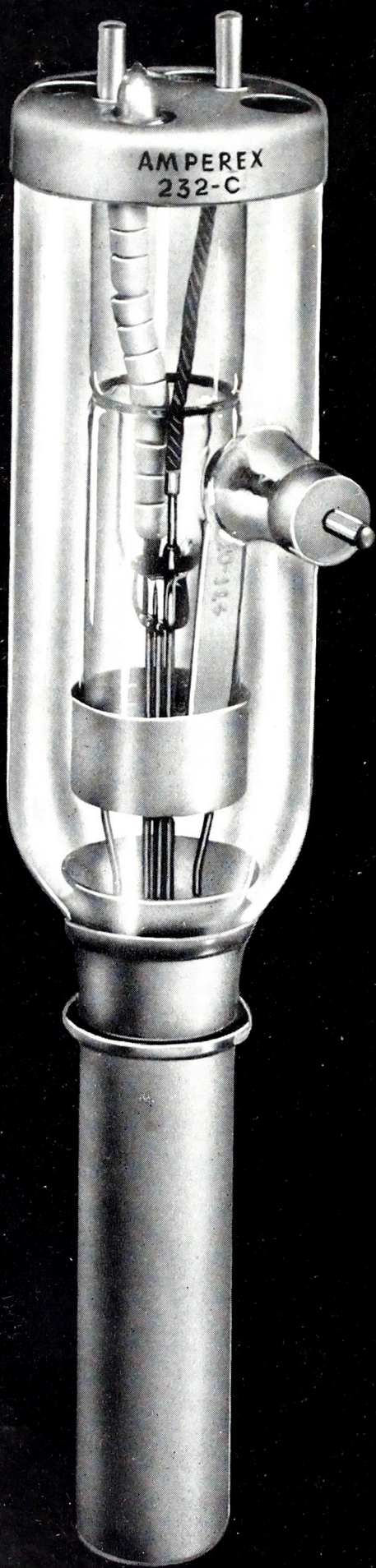

the 220-C and 232-C
AMPEREX
HEAVY DUTY TUBES

Similar to the new W.E. 342-A and 343-A

Have been operating satisfactorily in Broadcast transmitters where the original lighter filament types had proven both unsatisfactory in performance and in life duration.

Heavy rugged filaments of greatly increased emission capabilities is the outstanding feature of both of these Amperex Heavy Duty Types.

Effective shielding is provided for both the anode seal and grid support seals.

The grids are of the special Amperex design, where the cross wires are swedged into evenly and accurately spaced notches in the supporting rods. This exactness of spacing and absence of oxidation and brittleness in the Amperex mechanically constructed grids, results in uniform characteristics and trouble-proof operation.

220-C . . . \$290

232-C . . . \$480

AMPEREX ELECTRONIC PRODUCTS, INC.

79 WASHINGTON STREET

BROOKLYN, NEW YORK

electronics

A McGRAW-HILL

PUBLICATION

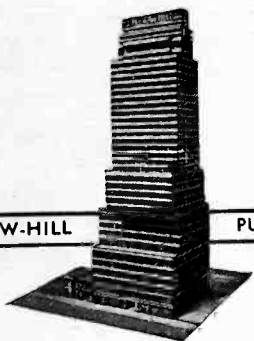

RADIO . . . COMMUNICATION AND
INDUSTRIAL APPLICATIONS OF
ELECTRON TUBES . . . DESIGN . . .
ENGINEERING . . . MANUFACTURE

KEITH HENNEY
Editor

DONALD G. FINK
Managing Editor

BEVERLY DUDLEY
Associate Editor

M. L. MATTEY
Assistant Editor

HARRY PHILLIPS
Art Director

H. W. MATEER
Manager

ELECTRONICS, February, 1939, Vol. 12, No. 2.
Published monthly, price 50c a copy. Subscription
rates—United States and possessions, Canada,
Mexico and Central American countries, \$5.00 a
year. All other countries, \$6.00 a year or 24
shillings. Entered as Second Class matter, August
26, 1936, at Post Office, Albany, N. Y., under
the Act of March 3, 1879.

Branch Offices: 520 North Michigan Ave., Chicago;
883 Mission St., San Francisco; Aldwych House,
Aldwych, London, W. C. 2; Washington; Phila-
delphia; Cleveland; Detroit; St. Louis; Boston;
Atlanta, Ga.

Contents Copyright, 1939, by
McGraw-Hill Publishing Company, Inc.

McGRAW-HILL
PUBLISHING COMPANY, INC.

JAMES H. MCGRAW
Founder and Honorary Chairman

Publication Office
99-129 North Broadway, Albany, N. Y.
Editorial and Executive Offices
830 West 42nd Street, New York, N. Y.

James H. McGraw, Jr., President
Howard Ehrlich, Executive Vice President
Mason Britton, Vice Chairman
B. R. Putnam, Treasurer
D. C. McGraw, Secretary
J. E. Blackburn, Jr., Circulation Manager

Cable Address:
MCGRAWHILL, New York
Member A.B.P. Member A.B.C.

CONTENTS—FEBRUARY, 1939

SPORTS ANALYZED BY ELECTRONIC TUBE Cover

Photograph by Harold E. Edgerton, showing complete swing of golfer, made with intermittent gas discharge lamp. For analysis of this cover photograph, see page 11

FOREST RADIO SERVICE, by W. W. Waltz 9

Importance of radio communication in fighting forest fires, with description of some of the equipment in use by the Forest Service

TUBE AIDS PHOTOGRAPHIC ANALYSIS 11

Use of intermittent gas discharge tubes in photography, and analysis of information contained in the cover illustration

NUNAN YARN TESTER, by Thomas J. Nunan 12

Photoelectric device for testing textile yarns is automatic in operation, gives more consistent results than other testers, does not depend upon subjective estimates

HIGH-GAIN, WIDE-BAND AMPLIFIER, by F. Alton Everest 16

Description of circuit and construction of laboratory amplifier having 90 db gain and frequency response flat within 3 db from 25 cycles to 2 megacycles

SYNTHETIC SPEECH 19

Tube generators produce synthetic sentences under control of trained operator

TUBE EQUIPMENT IN INDUSTRY 20

Tabular survey of non-communication electronic equipment. List of manufacturers and their products

NEW STANDARD VOLUME INDICATOR AND REFERENCE LEVEL, by H. A. Affel, H. A. Chinn, and R. M. Morris 28

New instrument for volume indication, and new reference level proposed for adoption in the communication industry

U-H-F POWER AMPLIFIER OF NOVEL DESIGN, by A. V. Haeff 30

Ultra-high-frequency tube, utilizing new principle of operation provides greater output; opens up new regions of the spectrum for communication purposes

DESIGN FOR EXPONENTIAL HORNS, by George H. Logan 33

NOISE AND NOISE MEASUREMENT, by Daniel Silverman 34

DEPARTMENTS

CROSSTALK	7
REFERENCE SHEET	33, 34
NEW BOOKS	35
TUBES AT WORK	36
ELECTRON ART	56
THE INDUSTRY IN REVIEW	62
PATENTS	72
INDEX TO ADVERTISERS	80



"WHAT DO YOU MEAN, -HOT?"

Old Man Centralab took his baptism in a furnace at 2500 F. He laughs at such temperatures as 200 degrees . . . the sort of heat he has to take sometimes when he is parked near a ballast resistor or a transformer in a radio receiver.

Even where chassis temperatures ARE elevated the Centralab resistor, with its complete ceramic construction baked at 2500 degrees, laughs at a mere 200 degrees. Where ordinary fixed resistors break down under temperatures of 200 or even less, Centralab is positively unaffected.

Join the thousands of Centralab addicts . . . specify Centralab for original equipment or replacements.

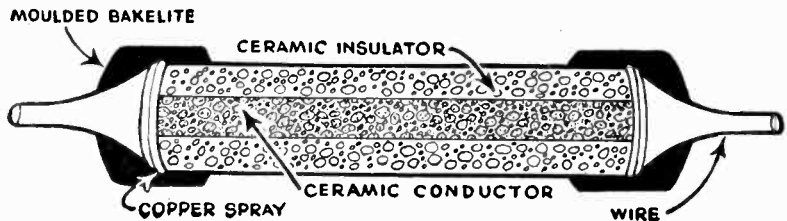

Baptized in fire at 2500 degrees . . . hard as stone. Center ceramic core, and ceramic jacket fired together to form a single shock-proof unit. Pure copper covers resistor end for wire lead contact.

CENTRALAB: Div. of Globe-Union, Inc.
MILWAUKEE, WISCONSIN

Centralab

CENTRAL RADIO  LABORATORIES

FIXED RESISTORS

AUDAX

Compensated-Inductor

MICRODYNE

Sweeps forward to universal acceptance



*f*rom the swaddling days of the Electric Pick-up, AUDAX has insistently championed the principle of Magnetic Flux as the only power source that would produce high-fidelity and day-to-day constancy.

This is a fact of Science, well known to leading Sound Engineers.

Some others, straying after Price, working their way through trial and error, have taken longer to accept this actuality — but even they are rapidly becoming converted.

The great many orders for AUDAX Pick-ups from sources hitherto classed by us as “skeptical”, witnesses the triumph of the Magneto-Inductive principle.

Our new MICRODYNE models, with their brilliant Compensated-Inductor refinement, are now STANDARD and MUST among the most exacting technicians.

We might have chosen the primrose path and deluged the industry with cheap pick-ups by sacrificing quality — but AUDAX just didn't know how to get down there. We never could. We give so much — our own quality demands are so stern — that AUDAX Pick-ups always come out as QUALITY instruments — and always will!

AUDAX Pick-ups and Cutters list from \$12.⁵⁰ to \$160.⁰⁰.

Write for interesting details.

AUDAX COMPANY

500 Fifth Avenue **New York City**

“Creators of High Grade Electrical and Acoustical Apparatus Since 1915”

FIRST!

Eimac "firsts" are piling up

First in power capabilities, in efficiency of design; first to eliminate sources of contaminating gas; first and only guarantee against tube failures which result from gas released internally.

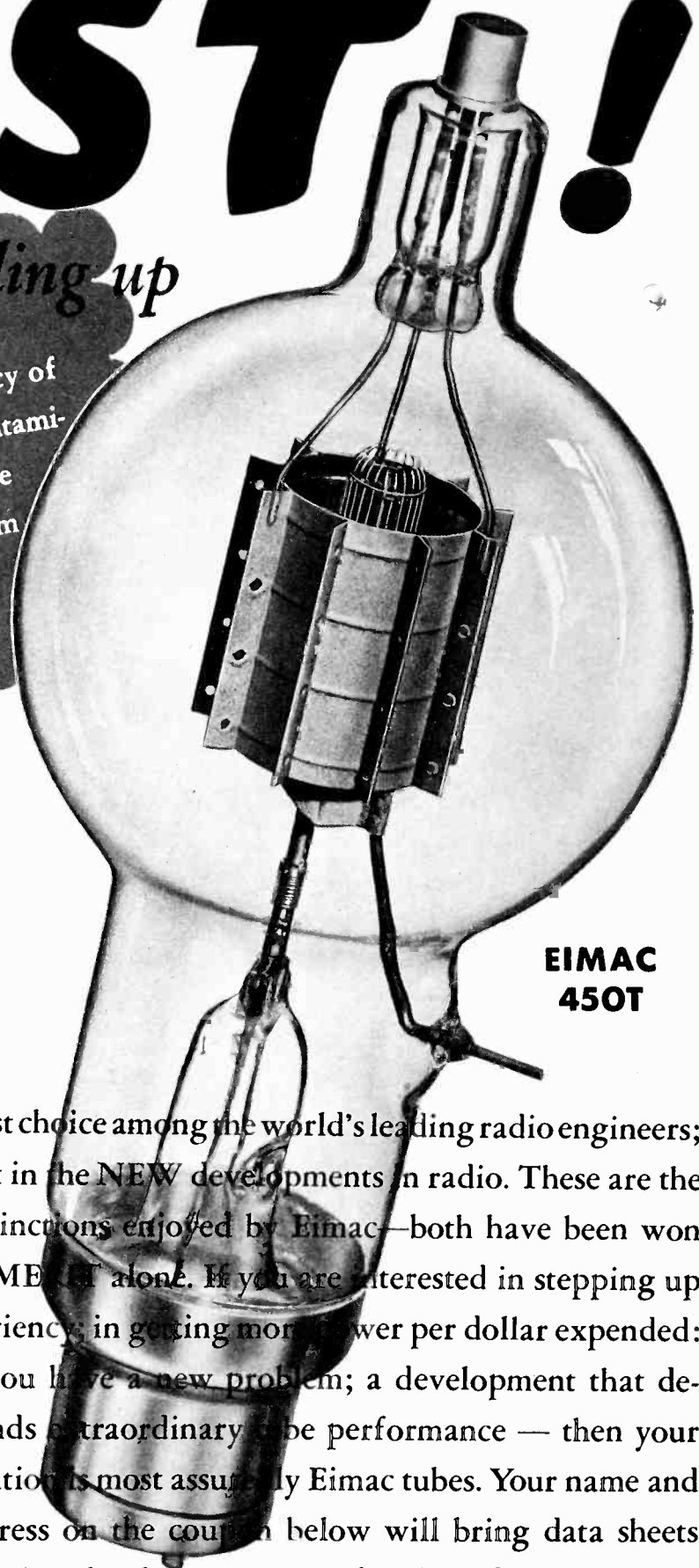

**EIMAC
450T**

First choice among the world's leading radio engineers; first in the NEW developments in radio. These are the distinctions enjoyed by Eimac—both have been won on MERIT alone. If you are interested in stepping up efficiency; in getting more power per dollar expended: If you have a new problem; a development that demands extraordinary tube performance — then your solution is most assuredly Eimac tubes. Your name and address on the coupon below will bring data sheets covering the characteristics of 450T and 250T tubes as used in the facsimile transmitter described at left.

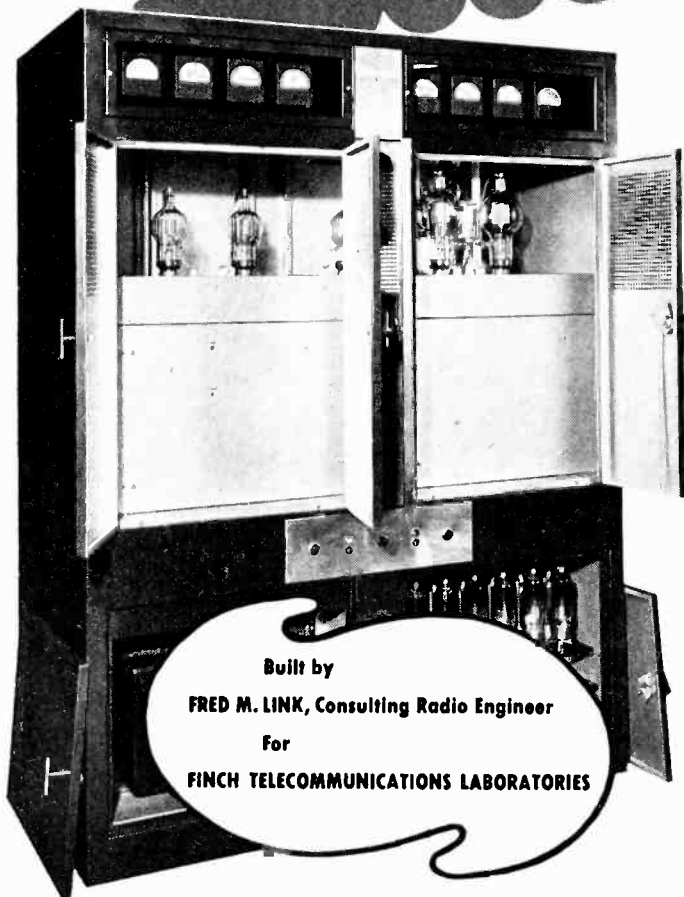

Built by
FRED M. LINK, Consulting Radio Engineer
For
FINCH TELECOMMUNICATIONS LABORATORIES

Crystal control 1000 watt ultra high frequency transmitter to be used for both facsimile and aural transmission. Operates on frequencies between 30 and 45 megacycles. 100% modulated at 1000 watts power. Class "C" amplifier uses two 450TH tubes in push-pull operating at 2500 volts; a 250TH as the driver. Modulator uses two 250TH tubes in class "B" audio.

Final tank circuit uses the new Eimac vacuum condenser.

Transmitter is expected to go on the air with daily experimental broadcasts early in Feb. 1939.

Built by **FRED M. LINK, Consulting Radio Engineer, 125 West 17th Street New York City, N. Y.**

Eimac
TUBES

EITEL-McCULLOUGH, INC.
Department E-1
San Bruno, California

Name _____
Address _____

"LAPP

GAS FILLED CONDENSER IN SERVICE EIGHT MONTHS

... no sign of trouble,"
says JOHN LONG, WHAM



John J. Long, Jr., has been with WHAM, Rochester, 11½ years, during the last 9½ of which he has served as Technical Supervisor. Previous to his WHAM connection, Long spent two years, 1925 to 1927, with WJZ at Boundbrook, N. J., where he participated in extensive pioneering work on 50 KW transmitters.

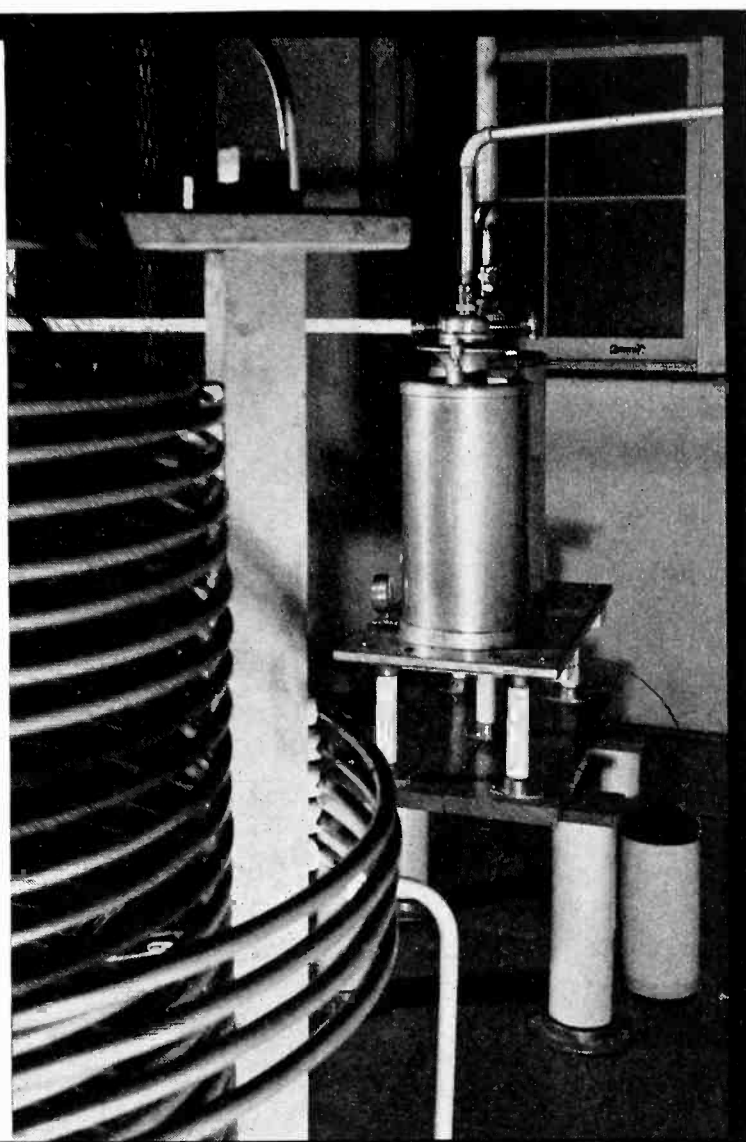

OUR Western Electric 306A 50 KW transmitter is coupled to a shunt-excited antenna by means of two Lapp gas-filled condensers, variable type, 400 to 1000 mmf. rating, connected in series. During the first few months we did considerable experimenting with this new type feed, involving frequent tuning adjustments on the condensers. Although the first of our Lapp condensers has now been in service eight months, it shows no signs of losing pressure. We particularly like the construction which enables us to vary the condenser setting while full power is going through it—and the fact that no number of adjustments

seems to affect the gas pressure. We find the tuning of our new shunt-excited antenna fairly critical and consider a condenser of constant capacity under varying temperature conditions practically a necessity. The Lapp gas-filled condenser is an efficient, workmanlike job, easy to handle, easy to install, and strictly worry-free. We're 100% pleased!"

Lapp gas-filled condensers are available in a wide range of sizes, of fixed, adjustable and variable capacitance, in three voltage ratings, and capacitance ratings 100 to 2000 mmf. Write for complete descriptive data.

LAPP

INSULATOR CO., INC., LEROY, N. Y.

MALLORY-YAXLEY Switches lend a hand on wash-day



The amazing
BENDIX Home Laundry
is equipped with this
MALLORY-YAXLEY Switch

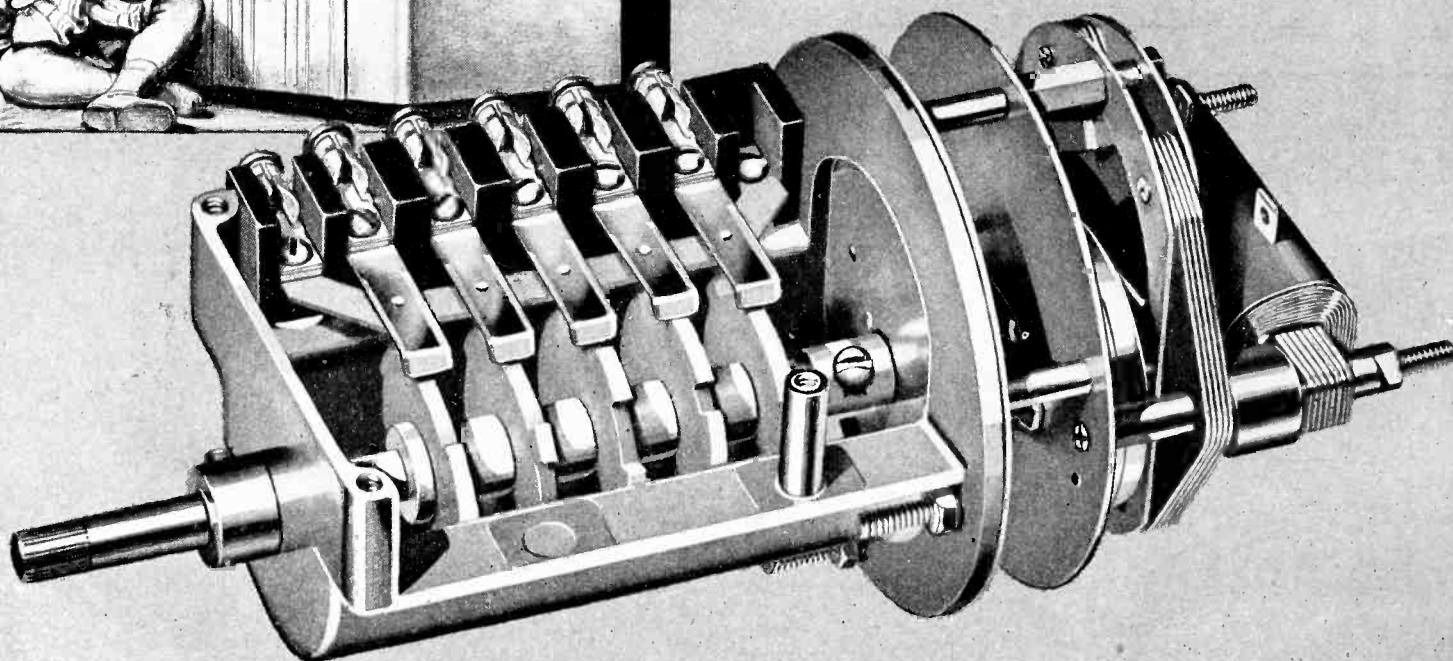

“Will wonders never cease!” exclaim Mr. and Mrs. America as they watch the Bendix Home Laundry do the family wash—*automatically*. At the turn of a switch, things begin to happen inside this white box. And they continue to happen until the clothes are all ready for the line.

To consumers, *here is a machine with a brain*. In a complete cycle of operations, it makes all the automatic moves required to wash the clothes, then rinse the clothes, and finally, damp-dry them.

A vital part of the “brain” is the Mallory-Yaxley Switch which was developed by Bendix and Mallory engineers—and now produced for Bendix by Mallory.

And that brings us to this point: if you have a switch problem, Mallory-Yaxley should be your first port of call. Here we have the tools, the parts, the experience and, above all, the will to make your dreams come true. Of course all Mallory-Yaxley switches have the long-life benefits of Mallory electrical contacts.

If it can be done by a switch, Mallory-Yaxley can do it! If it has never been done by a switch, we will help you try to find a way!

P. R. MALLORY & CO., Inc., INDIANAPOLIS, INDIANA

Cable Address — PELMALLO

Use
P. R. MALLORY & CO. Inc.
MALLORY
REPLACEMENT
CONDENSERS... VIBRATORS

Use
YAXLEY
REPLACEMENT
VOLUME CONTROLS

ELECTRONICS

FEBRUARY
1939



KEITH HENNEY
Editor

Crosstalk

► **QRM** . . . At a meeting in January between medical and communications men, the viewpoints of these two general groups of people on the proper use of high frequencies were aired. Diathermy machines have been creating widespread interference to communication circuits. This has upset the communications people because of the scarcity of ether bands. There has been talk of outlawing the use of high frequencies for purposes other than communication; a bill was introduced into the Senate last session which would give authority to the FCC to regulate all equipment using high frequencies.

On the other hand the medical profession is accomplishing certain remarkable results by the use of high frequency heating and cutting equipment. Physicians using this diathermy apparatus and manufacturers making it ask, rightly, whether high frequencies should be reserved exclusively to the communications people, or whether the medical profession cannot also use these frequencies.

At the meeting the FCC engineers and communications engineers presented remarkable data showing the interference created on television and other communications bands by diathermy apparatus. Demonstrations were given showing how this interference looks on an oscillograph and on a television receiver and how it sounds in a sound receiver. Records were given, aurally, showing the number of diathermy interferences at Riverhead, Long Island on a typical day when the skip band was such that these signals must have come from distances greater than New York. Evidence was given to show that a diathermy machine could be made to transmit communication over a thousand miles or more—and of course would cause trouble on any communication circuit in that distance.

The medical people presented clear evidence of the good that is being done with h-f apparatus not only by aural report but by means of color movies showing the use of the "radio knife" in removing growths from the face. This was mighty conclusive evidence to the communications people, many of whom left the room. The medical people left no doubts in the minds of the audience that means must be provided for the use of these high frequencies by the profession.

It has been proved that interference does not occur if the power lines are filtered and if the entire diathermy installation is placed in a shield. This means the apparatus, the doctor and the patient. An expenditure of \$100 per room would probably cover this shielding problem. But in a hospital there may be a hundred rooms, or more, in which a diathermy treatment must be given. The apparatus is, therefore, portable and is moved about. Equipment is being taken out to homes for treatment, and in some cases, equipment is rented to patients who treat themselves. Such portable apparatus cannot be shielded so easily.

It has been suggested that all medical apparatus be designed to operate on one of several frequencies, and that bands covering these frequencies be set aside by the FCC for use by the medical profession. There are objections to this procedure both by the communications people and by the medical men.

All that is certain is that the conflict must be amicably and quickly settled. Neither communication men nor medicos have exclusive right to the use of high frequency equipment. On the other hand, neither has the right to destroy or to injure the high frequencies for the other. Both need the wavelengths, both perform essential and important services.

► **VODER** . . . In January, the Bell Laboratories engineers demonstrated at the Franklin Institute in Philadelphia a most remarkable and beautiful machine. It is an assembly of oscillators and amplifiers which, when properly "played" will talk in a voice which resembles that of man, to a degree dependent only upon the skill of the operator. Not only words, but phrases and sentences come from the Voder's mouth.

This machine won't throw anyone out of a job; we don't see how anybody can get rich out of it. It is simply another proof that science can do practically any job set for it. Instead of worrying about the damage (sic) done to society by the machine and the engineer, why do not the worriers set the engineers tasks which would benefit man? Given the proper brains and a proper amount of money, the scientists can solve any reasonable problem—even to making a machine that will talk like a human. That only thing science does not seem able to do is to put a brain into a machine, or to make the brain of man the perfect reasoning machine it ought to be.

► **VULGAR** . . . In this issue will be found an extension of the Industry in Review department in which several recent commercial products are described with space more commensurate with the interest of the devices than a mere new products mention would provide.

There have been occasional feelings among readers that devoting editorial space to a description of a product which was for sale smacks of free advertising, that it constitutes a "puff." So far as the editor is concerned it makes no difference whether a device is advertised or not, or even if it is for sale. So long as it is interesting or useful to the reader, it merits space.



RADIO ON THE JOB IN THE NATIONAL FORESTS

Top—Portable radio in Siskiyou National Forest, Oregon. Map and alidade, and radio in Lolo Forest, Montana. Bottom—Fire dispatcher, Talledega, Alabama and radio at fire location, Deadwood Creek, Challis Forest, Idaho

Forest Radio Service

By

W. W. WALTZ

SELDOM if ever does the city dweller have occasion to report a fire, and when that occasion does arise the thought of radio never enters the picture. Red-painted alarm boxes on not-far-distant corners, or the telephone, provide quick response to the alarm—in a matter of minutes the fire equipment rolls up, and well-organized, highly-disciplined firemen go into action. True enough, radio has entered the fire-fighting game, but in the cities it is generally confined to communication between fire headquarters and roving units such as fire boats or the cars of commanding officers.

Fire prevention and control in the vast distances of the national forests, however, involves the active participation of radio communication—not only for purposes of reporting the existence of fires, but also in the actual fight against the fire. Here the fire may and often does present a battle-front as extended as that of many of history's major battles, and over terrain that no rational human would ever select either for fight or frolic!

There are no conveniently-located alarm boxes to call the fire fighters. As often as not there is no one within miles of the spot where a hunter's

carelessly dropped cigarette, or the smoldering ruin of a lightning-struck tree fans into flame on a sudden breeze. The only certainty is that if the fire continues to burn it will smoke. Sooner or later an alert observer on a mountain peak, or a "smoke chaser" on a pony or in a car, will spot the fire. Even then, the nearest telephone to district headquarters may be hours away. So radio steps in!

The observation station, high up on a peak, will have, in addition to instruments for translating the far-distant haze on the horizon into distance and probable magnitude of the forest fire, radio telephone for communication with headquarters. The "smoke chasers" may have one of the small portable radio sets of sufficient range to enable them to get a message through to some point where it can be relayed to headquarters.

Radio equipment intended for service of this nature must be engineered for the job. In this respect, the Forest Service requirements are not unlike those of the Army in that, for some sets, extremes of compactness

and light weight must be attained even at the expense of diminished range. In the case of other sets, weight is a negligible factor, and range of operation is paramount. In all cases, the equipment must be rugged and capable of being used by personnel whose radio training is necessarily incidental to their primary function.

The problem of radio for the Forest Service loomed so great as to warrant the establishment of the Service's own radio laboratory. This is located at Portland, Oregon, where the proximity of huge forest reserves, noted in fact and fiction alike for their terrific blazes, promised thorough trial of the laboratory's results under severe service conditions. It might be added parenthetically, that the experience of the Forest Service in asking some outside source to design the equipment was a contributing factor in the start of the Portland laboratory; evidently, the conception of "portability" to engineers working in comfortable offices and laboratories was, to say the least, at variance with that of forest rangers who had to carry the equipment over almost impassable country.

Problems other than actual equipment design soon presented themselves for the attention of the laboratory. Nothing was known, for instance, of the absorption effects of standing timber on radio waves. Nor was there much data available on short-wave transmission in mountainous country. The laboratory staff has had plenty of problems and the dispatch with which these have been handled and solved speaks well of this comparatively recent addition to the many governmental agencies concerned with radio communication.

Light in Weight; Long in Range

As might be expected, there are several types of radio equipment in use by the Forest Service. This equipment ranges from ultra-light-weight radiophones, transmitting and receiving both voice and code, and weighing about 15 pounds, to much larger, permanent-station apparatus requiring motor-generators for power supply and having a consequently in-

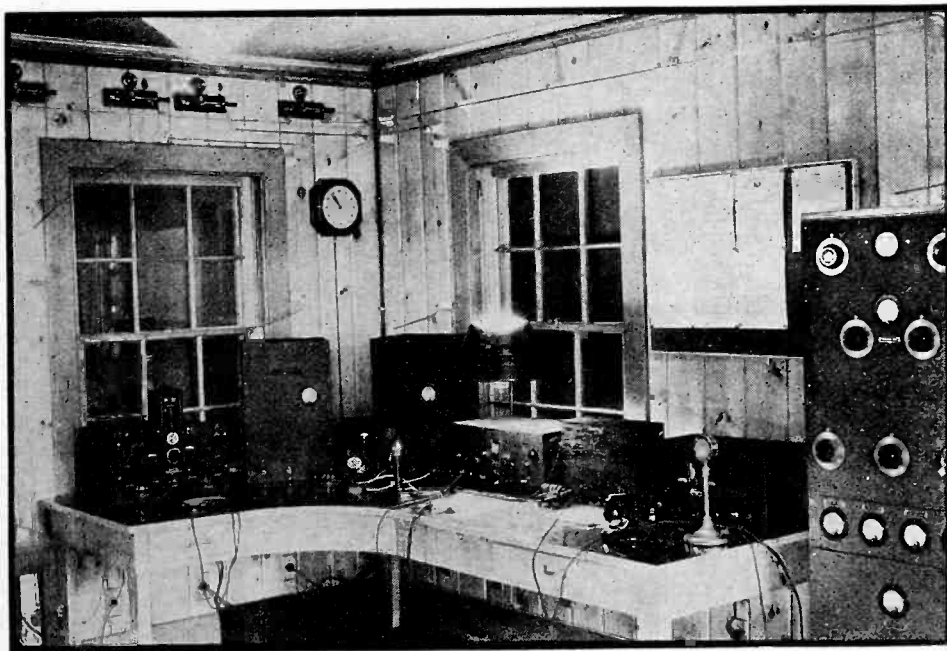

Radio Station operator's room at Missoula, Montana. All photos in this article are from the United States Forest Service

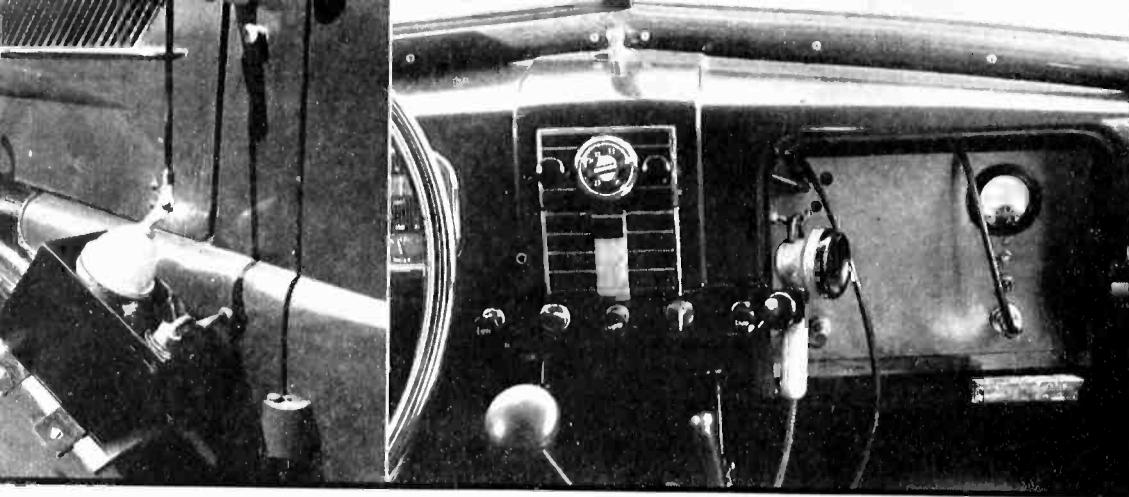

Example of U. S. Forest Service radio equipment antenna matching unit and auto installation

Portable radio equipment used in Region 6 of the U. S. Forest Service, Portland, Oregon

creased range and versatility of operation. Some pack sets have been designed which weigh but 9 pounds; however, due to the fact that these sets provide for c-w transmission only, although capable of receiving phone, their use is necessarily limited to those who can send code. A still more compact set for voice transmission and reception, weighing 8 pounds, was later developed and is the type furnished to the "smoke chasers."

Since aircraft are used to some extent by the Forest Service, both in the detection of fires and in their fighting—the application in this latter case is exactly analogous to the military use of planes for scouting—it is imperative that the aerial observer be in constant communication with the ground forces. Changes in the course of the fire are quickly

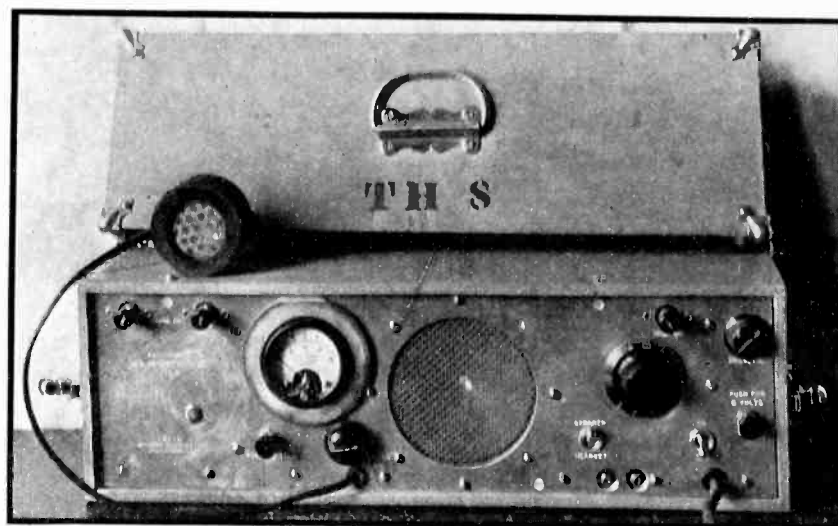

spotted and with the ground forces so informed, appropriate changes in the line of defence can be made. Radio equipment for use in the planes has been developed along with the other types and in some cases, plane and ground equipment are identical except for antenna arrangements.

One of the most recent highlights in the developments from the Portland laboratory is a portable set for use in cars or trucks of the Forest Service. Shown in an accompanying illustration mounted in a car, the set operates in the 3 Mc band and has proved eminently successful in establishing and maintaining two-way communication between cars and headquarters. Under the most adverse conditions the set is said to have a range of twenty-five miles, while tests have been made over distances up to five hundred miles. When it is realized that these results were obtained with nothing but a 7-foot metal fishing rod for an antenna, the capabilities of the equipment are realized.

No little credit for the exceptional results from this equipment belongs to the antenna-matching unit developed along with the radio set. This is also shown in an accompanying illustration; the unit serves to insure a perfect match between the antenna

and the circuits of the radiophone set. This particular point seems, to the outside observer, to have been especially stressed in all of the Forest Service equipment, and with good reason. Except for those locations where the installation is of a more or less permanent nature, the choice of an antenna setup may not always be ideal—in fact, under stress of emergency the antenna may be sketchy, to say the least. All available indications are that this equipment is so designed as to be as nearly independent as possible of antenna constants.

Frequencies used by the Forest Service radio are, in most cases, shared with other services. The possibilities of mutual interference on high frequencies are ever present. At a recent date, Forest Service channel assignments were ten in number, and ranged from 30,940 kilocycles to 39,420 kilocycles. Some channels in the 2500-3500 kilocycle band are used on a shared basis, although congestion in this band is severe.

It is desired to take this opportunity to acknowledge indebtedness to the Forest Service, United States Department of Agriculture, for assistance in obtaining this information and for making the illustrative material available.

Forest Service type of ultra-high-frequency airplane radiophone set complete with accessories

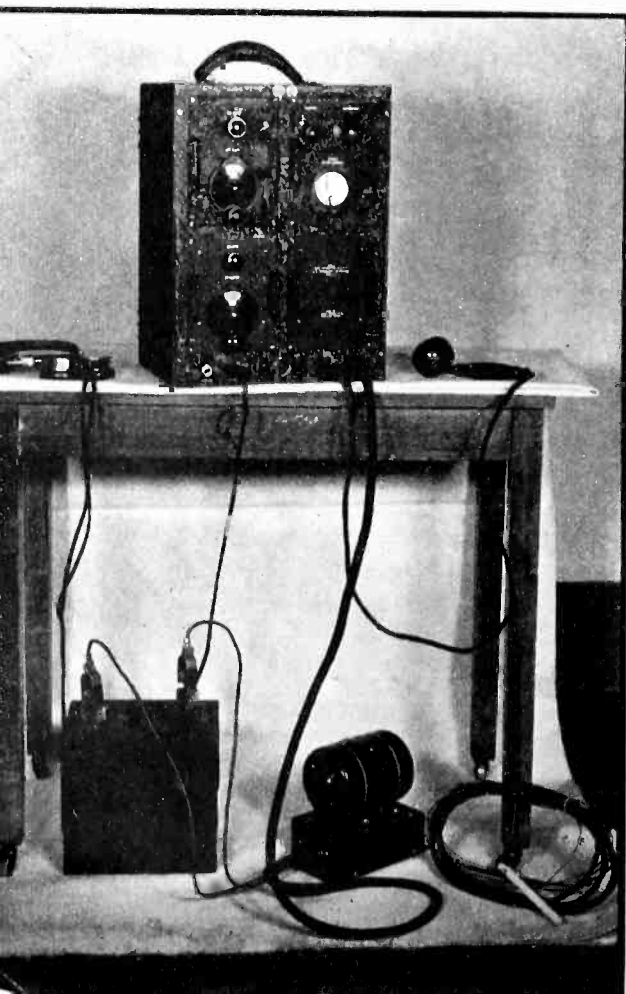

Tube Aids Photographic Analysis

Electronic discharge tube developed as an outcome of research on stroboscopic analysis permits making of photographs for the analytical determination of equipment operation

FREQUENTLY laboratory investigations develop into unsuspecting commercial enterprises, and the least promising of purely scientific research evolves into practical application and public acceptance after which, as Faraday once said, it might be—and usually is—taxed. The discovery of the “Edison effect” lay dormant and unused for years before Fleming and DeForest, backed by the “pure science” researches of O. W. Richardson on thermionic emission, made the vacuum tube the backbone of an entire communication industry, to say nothing about the door openers, color matching devices, and related applications described in another article in this issue.

One of the most interesting and fruitful of recent developments in the technique of measurement using electron tubes has come out of the application of the stroboscope to the examination of rotating and reciprocating apparatus. But the methods originally developed for stroboscopic analysis have been extended so as to be suitable for the analysis of transient as well as steady state effects, and are, consequently, no longer restricted to use in those cases involving repetitive motion.

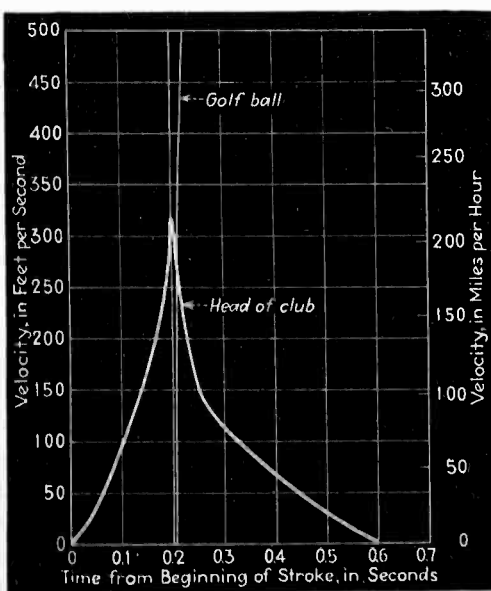

Fig. 1—Velocity-time curve for head of club and golf ball

Chief proponent of the photostroboscopic and related methods of measurement and analysis within the last few years has been Harold E. Edgerton whose contributions, together with the differential analyzer, cinema integrator, Hardy automatic recording spectrophotometer, network analyzer, and several machines for solving high order simultaneous algebraic equations have made Cambridge the focal point in the field of technical analysis. Interestingly enough, practically all of these pieces of analytical equipment, developed at the Massachusetts Institute of Technology, make use of electron tubes somewhere in their construction.

The cover of this issue of *Electronics* was made using a gaseous discharge lamp and associated circuit which produces a bright flash of light for a few microseconds, the successive flashes occurring 1/100th of a second apart. The photograph is particularly interesting because of the very considerable amount of information which, under proper analysis, it conveys. This information relates not only to the stance and stroke of the golfer, but to the stresses, velocities, accelerations, and deformations of the golfer's body, the club, and the ball. All in all, a single picture of this type conveys a whole story to the golfer concerning his technique, and one manufacturer of sporting goods (A. G. Spalding) has adopted the photo-flash technique as an aid in developing and improving their products.

In order to determine the essential data from the photograph, it is necessary to know that the camera lens was opened during the entire duration of the exposure, and that the component exposures occurred every 1/100th of a second. Some known distance is also required, and this is provided by the wooden bar, near the golf ball, which is marked off in feet and provides a convenient scale.

An approximate analysis (which

neglects the fact that the photograph does not show a normal projection to the plane of swing of the club) was used to derive the following information. Since there are 59 distinct exposures, 0.01 second apart, the entire swing was completed in slightly more than one half second. The stance of the golfer throughout the swing is clearly indicated, and the photograph shows the cross over of the hands as the ball is struck. The distance the club head has travelled between successive exposures is a measure of its velocity. The velocity of the club head and of the golf ball are shown graphically in Fig. 1, from which the acceleration has been derived, as shown in Fig. 2.

Assuming that the ball weighs 0.1 lb., its acceleration at impact is 50,000 ft/sec² and the force at impact is 5,000 lb or 2.5 tons. The initial kinetic energy imparted to the ball is $\frac{1}{2}mv^2 = 125 \times 10^6$ foot pounds, while the momentum is $mv = 5,000$ pound feet per second.

From an examination of the shape of the shaft, it is seen that the head of the club advances ahead of the projection of the shaft before the ball is struck, whereas after-impact, the head is retarded.—B.D.

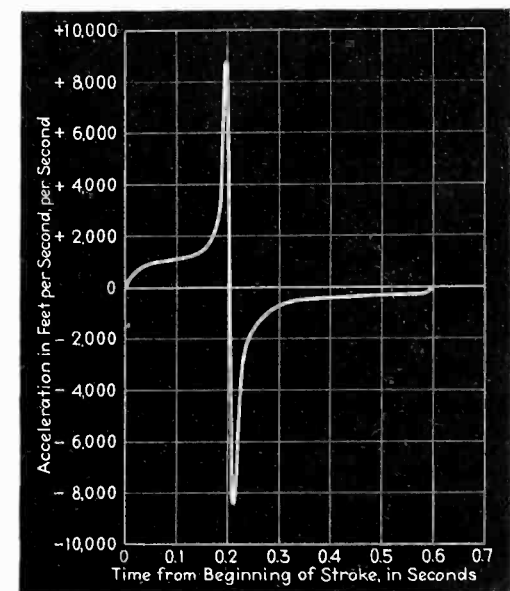

Fig. 2—Acceleration-time characteristic for club head

The Nunan YARN TESTER

By THOMAS J. NUNAN
New York City

CONSIDERING the fact that clothing has always been a necessity to civilized man, it is not hard to understand why the textile industry has been second only to the food industry with respect to volume of output. The 100 year period from Kay's invention of the fly shuttle in 1733 to the death of Samuel Slater showed the greatest development in the industry up to that time. Yet when these methods are compared to those of today, they are completely outmoded by our advanced machinery and new inventions. However, the basis of the industry remains practically the same. Yarn is still the final product of some process, new or old, of spinning or twisting animal, vegetable or mineral fibres into a single thread.

The thread making industry is based upon the fact that these animal, vegetable or mineral fibres cling together and can be drawn out to form a slender and continuous thread. The quality and physical characteristics of this product depend upon various different factors. Among these are the raw material used, hygroscopic and temperature conditions, skill and methods of manufacture, and conditioning of the finished yarn.

Today in the face of the influence of the customer and the tremendous competition in the field, it is a necessity that a manufacturer produce the best possible product and, what is just as important, one that is uniform. To control uniformity, a constant check on the quality of the product is compulsory after every stage of operation. As a final check the finished yarn must be constantly sampled and tested, for size, number, and strength.

This need for testing was recognized in the early stages of the industry. The original method was known as the "hand strength test", and in some mills, especially in

Europe, it is still being used by the "old timers".

In making a "hand strength test", a wooden disk with a protruding dowel is used. At the end of the dowel is a hook which is used to catch a loop made in the test sample. Small weights are slipped over the dowel to increase the load as desired. The tester attempts to lift the weight with the thread, adding unit weights until the thread will no longer sustain the strain. The procedure is then to remove a small amount of the total load, and if the sample is capable of sustaining the resultant load without rupture, its 'strength' is thus determined.

The drawbacks of this means of testing are fairly obvious. In the first place, there is no means to determine the maximum or minimum breaking points of the samples. Other factors which can affect the breaking points are the rate at which the load is applied, and the obvious differences caused by different testers. Because of these factors, it is impossible to obtain comparative results.

One of the first known attempts to improve upon this method was made by Charles O'Neil, an inventor and manufacturer, in Manchester, England, in 1863. His machine provided a means for holding a piece of thread between two jaws. The upper jaw was stationary while the lower jaw was attached to a water float. To bring tension upon the sample, the water was allowed to escape from the float container causing the float to sink. Upon reaching the ultimate tensile strength of the thread, the water was measured, and by referring to tables calibrated for the purpose, the stress was calculated.

Later types came into existence as the demand for mechanical testers grew. Among them were the balance types, followed by the spring types and still later by the pendulum

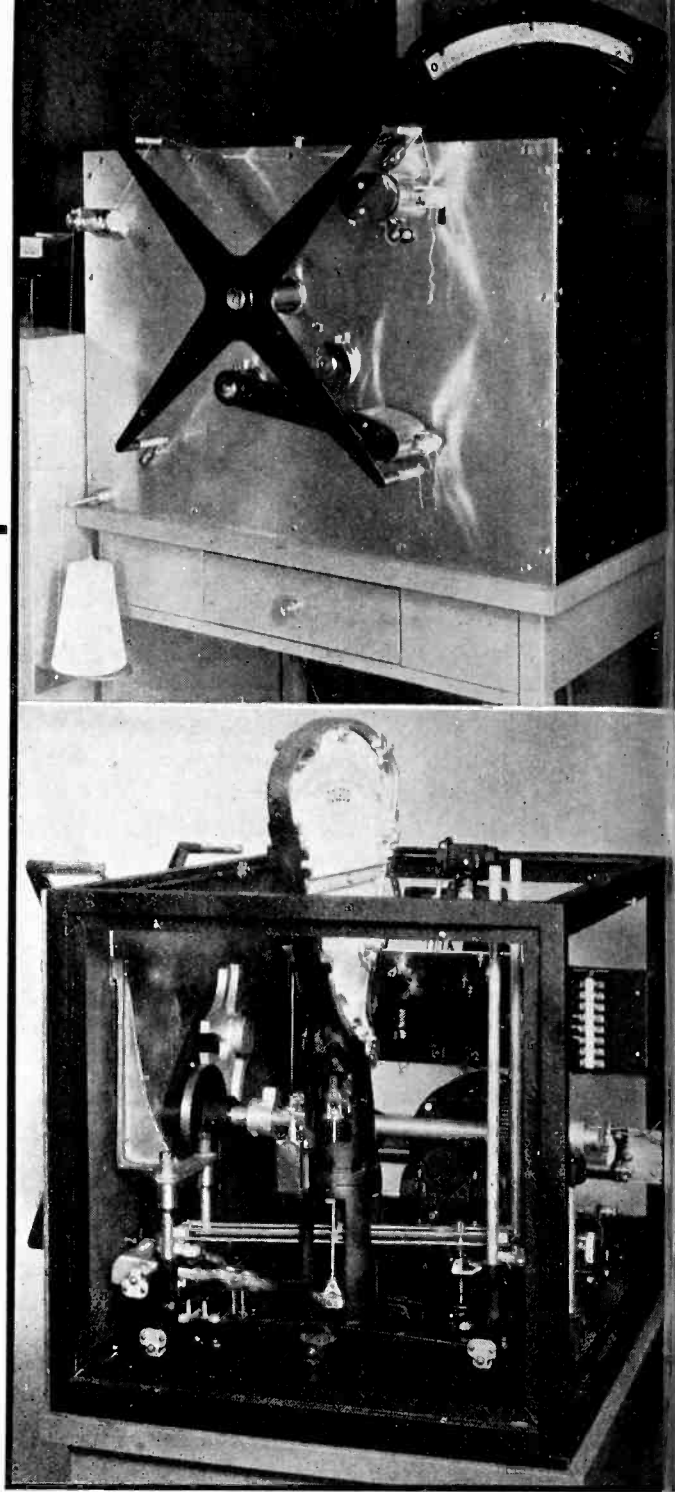

General views of yarn tester. Upper left—Yarn, placed between magnetic grips, has been broken by downward motion of lower grip. Upper right—Close-up of photoelectric units showing light sources.

or dead weight variety, which are widely used today. Of these, the most accurate is the Schopper tester. However, for production testing it has the disadvantage of being slow.

The Scott tester, generally used in this country, is very similar in principal and is faster. A weighted pendulum is balanced on roller bearings and a small grip is attached to the hub by means of a chain. At the bottom of the pendulum is a pointer having several light pawls which travel over a scale cut in the shape of an arc, the inner surface of which is cut with ratchet teeth. Directly below the upper grip and

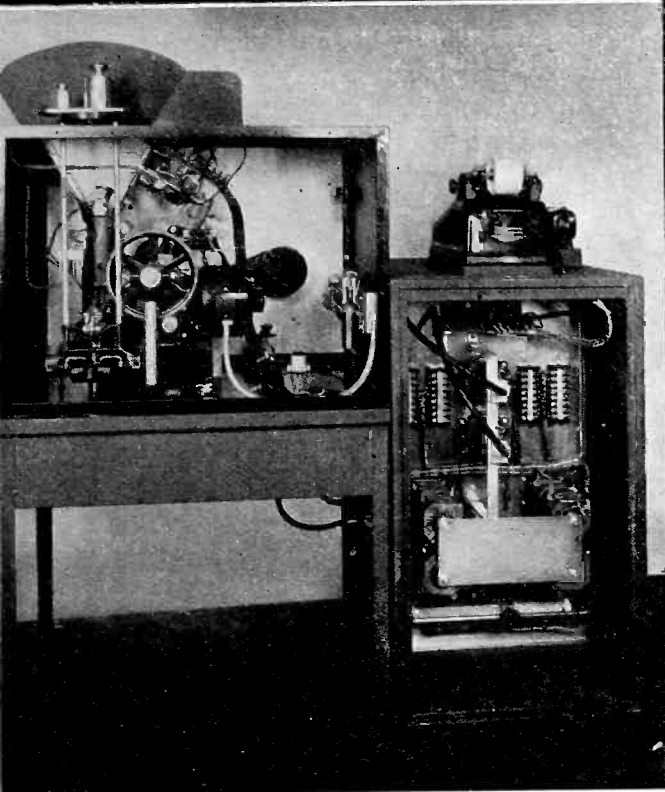
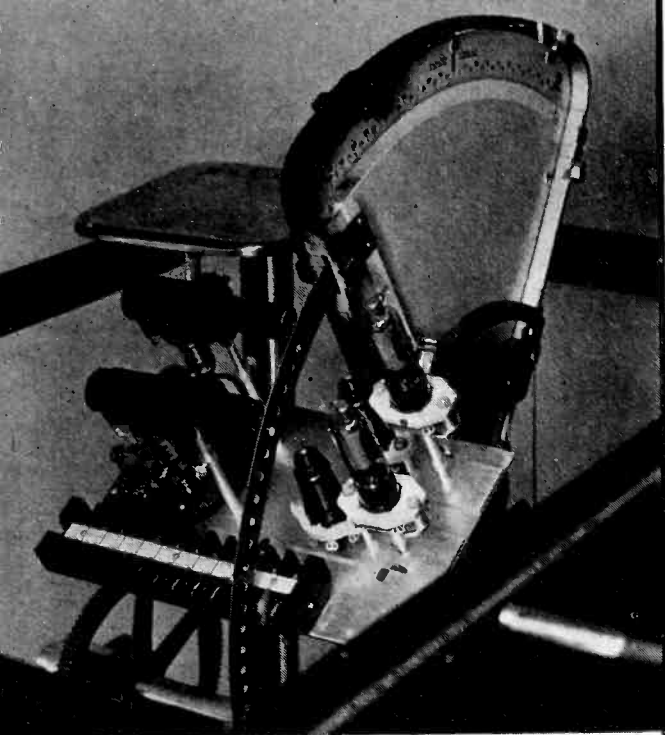

Dow metal shutter and phototubes. Lower left—Side view showing Geneva cam feed. Lower right—Rear view of yarn tester complete with totalizing and control equipment

separated by ten inches when at its full height is the other grip, attached to a strong column that may either have a ratchet attached or a screw thread so that it can be slowly and evenly drawn down by an electric motor or by hydraulic means. The standard speed at which the two grips move apart is equivalent to twelve inches per minute.

In making the test on this type of machine, the operator places a sample of yarn between the upper jaws and then screws them up tight. The yarn is then brought down to the lower grip and similarly fastened. Power is then applied and the jaws tend to move apart. The pendulum

An automatic device which tests and records the strength of yarn, stops operating when breaks occur to permit examination of the rupture, again demonstrates the remarkable versatility of electron tube equipment

starts to move through its arc placing a strain upon the thread until the sample breaks. The word break is used advisedly because in the majority of tests the fibres making up a piece of yarn actually pull or slip past one another. When the break occurs, the pointer is held at its highest position by the pawls, until released by the testing operator after having read and noted the scale reading. The grips are then unscrewed, the broken pieces of yarn removed and the test repeated with a new sample. Usually ten breaks are made from each sample and the results are then averaged. This average, compared with a known average found through years of experience and thousands of breaks, classifies the condition of the sample. This process is tiring work and an operator working eight hours a day is apt to become careless. The fingers are hard taxed by the repeated tightening and loosening of clamps.

There has been a need for a tester which would be completely automatic in its operation, thus eliminating any human error; one that would operate at great speed so as to fit in with our high speed production methods and give uniform and comparative results, regardless of where the test is to be carried out. There has been recently developed a new tester called the Nunan Tester. This machine is completely automatic in its operation and meets the requirements mentioned above.

An Electronic Tester

Attacking the problem, the inventor decided to use a springless type of scale of a standard make, which would be rugged and able to withstand abuse caused by constant use. Electrically operated thread grips were designed and then the method of picking up successive lengths of thread and feeding them between these grips was perfected. The next problem was

to make the scale record its own readings. The various types of recording scales on the market were rejected as unsatisfactory, as were various inductive and capacitative methods of recording because none proved rugged enough to be used in a machine that would be turned over to non-technical workers in the factory. The prime requisite was stability and simplicity. Finally electronic methods were tried. An arc made of Dow metal was attached to the scale pointer and holes, one for each division on the scale, were accurately plotted and punched. On one side of the shutter was placed a phototube and opposite it a light source with a lens that would bring the beam down to a pin point within an inch of its surface and then diverge again. The idea was to utilize the impulses set up through the amplifier every time the light struck the phototube to advance a selector switch (step-by-step relay). Thus if the pointer moved five divisions, five impulses would be set up and the switch would step ahead a corresponding number of places. From then on it was merely a matter of getting some kind of record of this movement. The original scheme was to use counters, electrically operated, to represent each scale division and if the pointer moved to fifteen-twentieths of a pound, for example, the corresponding counter would indicate 1. If the next displacement was to ten-twentieths, the counter representing half a pound would register 1. At the end of the tests the various counters would show numbers indicating how many times the pointer had stopped at its corresponding scale division. The operator would then note these readings and reset the counters before resuming the test. However when a unit like this was built it immediately became evident that the manual reading it required would lead to error, and except for an improvement in the weighing mechanism, was

of no advantage over the older types of testers. In addition, there would be too many counters required.

The solution to the problem came with the idea of using a ten key electric adding machine of standard make. At first magnets with extending arms were made to depress the keys but later the bottom plate under the keys was cut out and eleven solenoids were mounted directly underneath and one connected to each of the keys, and one to the "motor bar".

The electrical circuit beyond the point of the selector switch had to be considerably altered from the one used to operate the counters so as to enable the printing of two and three figured numbers, and then to actuate the motor bar in the proper sequence and with the correct time interval so as not to jam the adding machine.

This idea worked after a fashion, but the selector usually jumped ahead extra places and the readings were usually higher than those indicated by the pointer on the scale. This was found to be caused by vibration of the shutter when only partly cutting the light beam as it came to rest. To remedy this condition another phototube was mounted and the number of holes in the shutter was decreased, to allow the spacing of the two tubes so that one would receive light from the even numbered graduations, while the other tube would receive light from the odd numbered graduations. A locking system was thereby devised, which eliminated any jumping caused by vibration of the shutter. When sufficient light reached the phototube the relay would operate, but would then remain inoperative until the next phototube could function. In this manner vibration of any kind can have no adverse effect.

The distance between the jaws was made the same as the accepted standard which is ten inches. The load rate was made twelve inches per minute. The jaws were large round disks and designed so as not to damage the yarn.

The first complete model was tried for several months being used in a large thread mill eight hours a day. The results were compared with those obtained by careful operation on a Scott Tester and on what is known as an Anchor machine. (This latter uses springs.) Tests were so satisfactory that a second machine was built and immediately thereafter

Rear view of electron tube yarn tester with covers removed to show interior construction

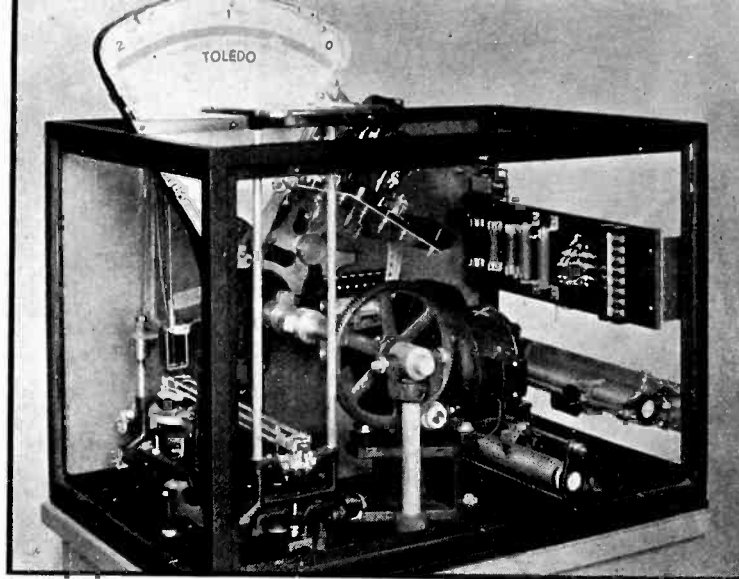

two more, one of which was sent to one of the largest mills in Paisley, Scotland. Six months later five additional machines were ordered incorporating numerous improvements that had suggested themselves. A counter was added to indicate at any time how many breaks had been made in a test, since there was often a need to tests hundreds of breaks to check the evenness of a spool or cone. A 'weak break' stop also was incorporated to stop the machine if a specimen of yarn just pulled apart due to an extremely weak spot without the pointer moving. This addition indicated a weak spot on the recording paper for future record and also allowed the operator to examine the thread and note just why it was so weak (knot, acid spot etc.).

The Machine in Operation

The operator sets the switch to a number corresponding to the number of breaks required. It may be ten, fifty, or more. Fifty gives a very good "picture" of the yarn condition.

The thread is placed upon the stand passed under the variable tension device and draped over the two top arms. The starting switch is then thrown and the four arms move through an arc of 90 deg. The magnetic jaws open during this cycle and the thread that was laid on top is now drawn between these jaws which close immediately after the arms come to rest. The lower jaw is driven downward by a cam and the top one, attached to the scale, is made to follow by the intervening section of yarn until the yarn is so strained that it ruptures. The scale pointer meanwhile has been following the movement of the top jaw causing the selector relay to step ahead, because of the interrupted light beams, one point for each scale division. When the pointer comes to rest (being held

by pawls) the various relays drop out in sequence allowing the solenoids attached to the under side of the adding machine to become momentarily energized causing the figure adjacent to the pointer to be lined up on the adding machine and then the "motor bar" is pulled down printing the number.

All relays immediately drop back to the starting position, the jaws open, the scale returns to zero and by means of the Geneva cam the motor moves the arms another 90 deg. bringing a new specimen of yarn between the jaws and the cycle is repeated until the required number of breaks has been made. The machine is then automatically brought to a stop. As the arms swing around bringing a new specimen between the jaws the strand of yarn just broken is removed from the minor grip and is dropped on the floor or into a basket.

The automatic tension device at the upper left of the panel only exerts tension upon the yarn while it is being pulled between the jaws. Then all tension is released so that there will be no back pull on the upper or scale grip. The dash pot on the scale only works when the scale is returning to zero. No hindrance is allowed in its operation while the pointer is being actuated by the pull placed upon the thread under test. This is because the pointer must register at all times the strain placed upon the yarn at each particular instant and no lag, as in ordinary weighing procedure, can be tolerated. Otherwise it is obvious that the pointer would be behind its "true" position when the yarn ruptured.

A certain weight, to increase the range of the two pound limit of the scale dial, can be placed previous to the test upon the rear platform of the scale. This weight is chosen so that the average break occurs in the

center of the scale which therefore gives very close vernier readings. The weight must of course be added to the column of figures after their addition on the adding machine before the average is taken so that the true result is obtained. This latter operation is the only time the human element comes into the recording procedure.

The Electrical Circuit

The operation from the interruption of the light beams to the actual printing is as follows. The holes in the shutter are so spaced that when the pointer is opposite the first graduation (1/20th lb.) the first light beam, representing the odd numbers, is allowed to strike the phototube opposite and the impulse thus set up is used to energize one coil of a polarized relay. This relay after each breaking operation assumes a position with its armature against the pole piece energized by the "even amplifier". Upon the first impulse it receives in the next breaking operation it will therefore be in a position to pull over and transmit that impulse further along the network. As the pointer moves up to the next graduation the other cell-amplifier relay coil will be energized pulling the relay back again.

The armature of the polarized relay starts from the lower position and as it moves to the upper one, for a fraction of a second current is allowed to pass (through a relay train) to transfer the impulses from the amplifiers into power impulses to operate the rotary switch. In a later model this is accomplished by the use of thyratrons, resulting in much faster operation. The operation of the recording devices is effected by other relays.

Relays are connected up in such a manner that if a piece of thread is fed between the grips but breaks or pulls apart due to the particularly weak spot without the pointer having moved, the machine will stop so that that piece can be examined—at the same time the adding machine is made to register a blank space so that notation can be made as to its cause. Relays are used to stop the machine after a predetermined number of breaks have been made.

In the later model a great many of the relays formerly used have been eliminated by the use of thyatron tubes. Eight relays are replaced by a motor operating contactors through the action of cams. The motor is set in motion when the impulses cease and makes one revolution. The machine is thus greatly simplified.

The Nunan tester is built in two sections. One contains the mechanical breaker, motor drive, scale, phototubes and pre-amplifier, while the other contains the power control, printer, selector relays, and amplifier. Unit 1 could, with slight changes, be used independently of unit 2. Automatic feed could still be had, as well as the use of a weighing mechanism that is rugged and reliable. However the results of each break would then have to be recorded by the operator. The amplifiers and relay units are mounted so as to allow them to be removed easily for cleaning or inspection purposes.

Since the machine is usually operated in a room where the humidity is maintained at 70 per cent, all the interior metal parts are cadmium plated, so as to withstand the constant moisture conditions. The panel has an egg shell aluminite finish so as to allow any color thread to be visible to the eye, against the background.

Meters are provided to check the a-c and d-c voltages and by the use of Variacs these voltages are adjustable over a wide range to compensate for supply differences when installed in different locations and also line fluctuations found at different times of the day. Voltage regulators could have been used here but the cost was unwarranted.

A comparison of the Nunan tester with the pendulum type of testing machine shows that two sources of error commonly found in the latter machine, have been practically eliminated. The first is the frictional error caused by the bearings used in the pendulum type testers. These are usually packed with grease, which must be kept fresh and clean. The bearings in the Nunan tester are hardened knife edges working on agate rests. The second common error is the result of the inertia of moving parts. The weighted pendulum moves through a large arc increasing the chances of error due to inertia. The total latitude of movement in the Nunan tester of the weighted parts is $\frac{1}{4}$ of an inch for full scale readings!

These features combined with the fact that the machine is entirely automatic in its operation and recording, giving uniform results, without error, with the speed necessary for our modern fast means of manufacture, show its superiority over all other types of yarn testers.

Complete yarn tester. Totalizing counter to left of adding machine.
Electron tube control equipment is contained in the cabinet

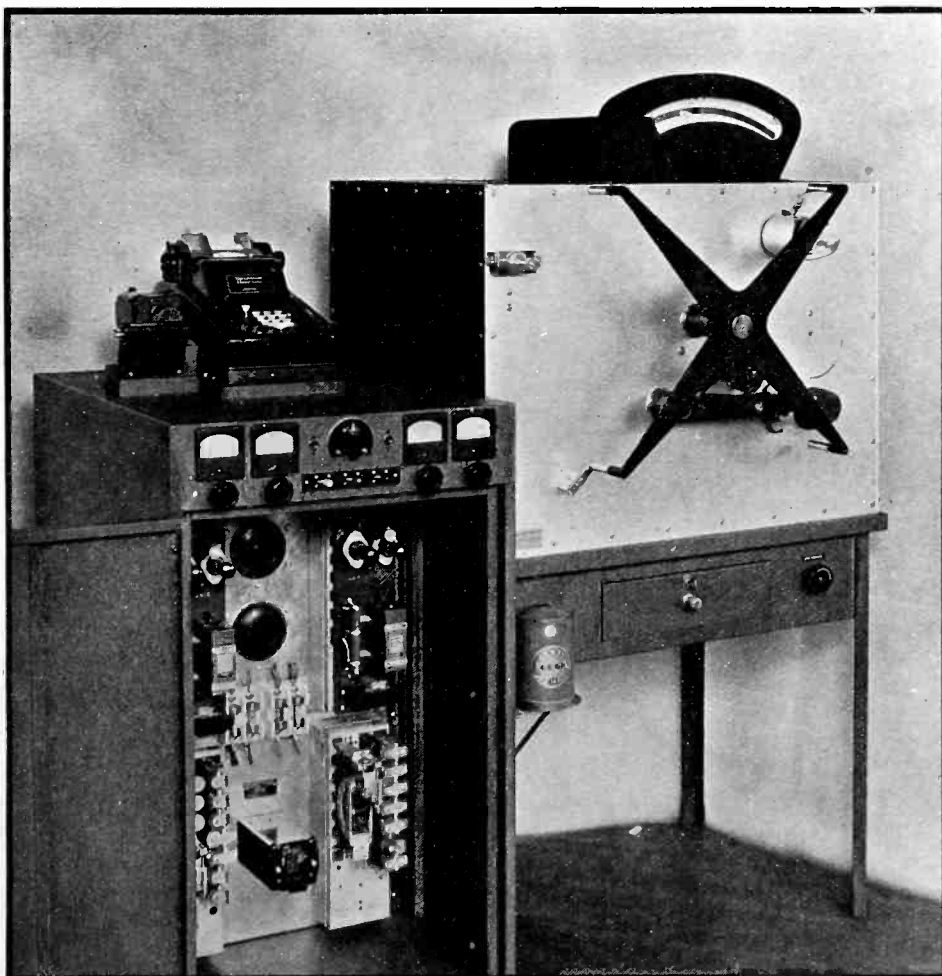

cycles wide. The introduction of the high transconductance tubes has made the use of this type of feedback not only possible, but highly desirable. With a 1250-ohm plate load resistor, and a 150-ohm cathode bias resistor, the feedback factor (β) is 0.12. With bypassed cathode resistor the actual gain would be 11.3, but by utilizing the advantages of feedback by removing the bypass condenser, the gain falls to approximately 4.8. This is still an appreciable stage gain considering the fact that 1250 ohms is still so low that the normal shunting capacitances do not cause the response to fall appreciably below 2 megacycles. It was not necessary to compensate stages 2, 3, or 4 for high-frequency loss of amplification on account of this.

Stage 5

Because of the 1851 tube bias point of 2 volts, the maximum signal which can be applied is less than two volts peak. To supply enough voltage to drive the power tube to a reasonable extent, stage 5 must have a much higher gain than any of the intermediate stages. For this reason stage 5 uses a cathode bypass condenser and has a gain of 18. Because the 100 microfarads is insufficient bypass

for the lower frequencies, some low-frequency compensation is introduced in the network C_1R_1 . This plate lead filter of the preceding four stages is likewise low-frequency compensation, but because of the 16 microfarad condenser, the point of action is at such a low frequency that the amplifier does not respond. This low-frequency correction takes place by virtue of the increase in total plate load impedance (and hence stage gain) as the frequency is decreased due to the poorer bypassing action of C_1 . The overall low-frequency response of the amplifier can be controlled considerably by a variation of the value of C_1 .

Stage 6 and Power Supplies

Cathode feedback is utilized in stage 6 to minimize the distortion arising within the tube. The relatively high plate load resistance of this stage necessitates considerable high-frequency compensation, which is given by the 1.3-millihenry inductance.

The conventional rectifier-filter power supply serves well for amplifiers of this type provided the plate supply for the early stages is well filtered. Experience has shown that heating the early stages with a stor-

age battery substantially eliminated all traces of hum, indicating that the a-c heated cathodes and their associated wiring are the greatest offenders. Careful shielding of heater wiring will minimize the electric effect, and careful twisting of the wires will tend to balance out the hum arising from magnetic coupling. The geometry of the base arrangement is such that the heater wiring can be removed only a certain distance from the plate circuit of the tube, and of course the plate circuit of the first tube is coupled directly to the grid of the second tube. For amplifiers whose gain exceeds approximately 90 db, batteries are recommended for heating the cathodes, and possibly for supplying the plate power of the low-level stages.

The question of how many stages to operate from one power supply was settled in a manner that eliminated any possibility of "motorboating", rather than lessen the tendency toward it. For relaxation oscillations to be set up, it is necessary for the plate circuit of one tube to be coupled to the grid circuit of some preceding stage with the proper phase relationships. At least three stages operating from the power supply are necessary to give the proper phase relationships to sustain these oscillations. The operation of only two stages from the same power supply eliminates the possibility of "motorboating"—an important factor where the gain is appreciable—down to very low frequencies.

The power supplies are conventional in every respect. The power supply for stages 3 and 4 is probably filtered better than actually necessary for this function. By closing the "filament voltage" switch, all heaters and filaments are energized. The closing of the "plate voltage" switch grounds the center tap of the high voltage windings of all power transformers, applying the plate voltage to all stages simultaneously.

Response Characteristics

Figure 2 shows the overall frequency response of the amplifier as given by actual laboratory measurement. For the high-frequency measurements, a General Radio Standard signal generator (Model 605-B) was used. A calibrated output attenuator is incorporated in this instrument so that the amplifier input signal could be adjusted at will. The output volt-

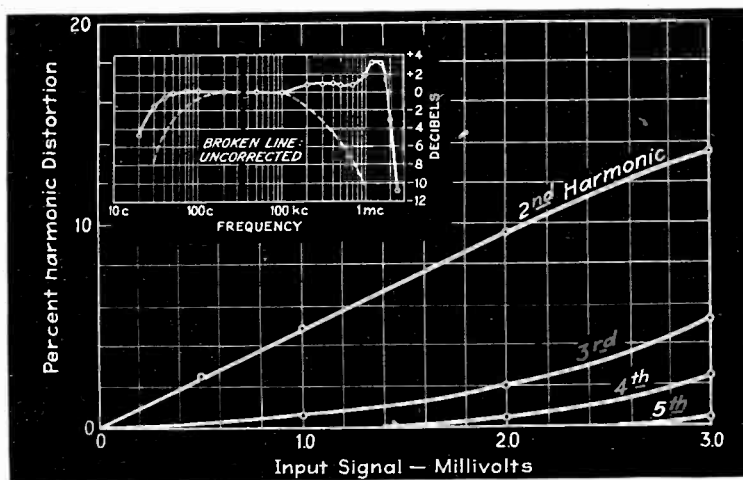
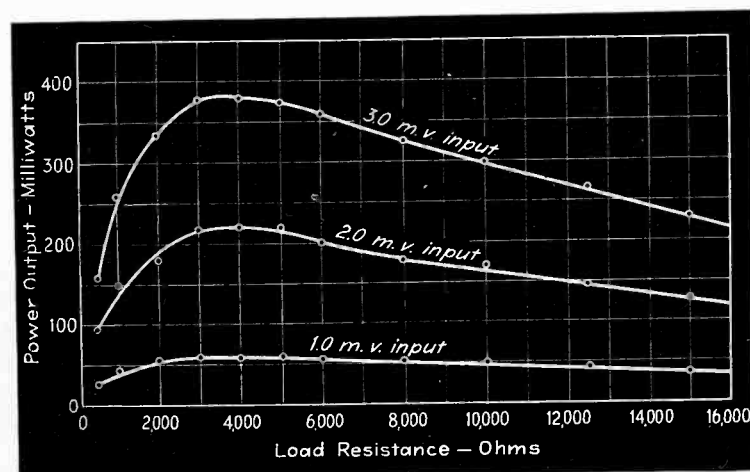
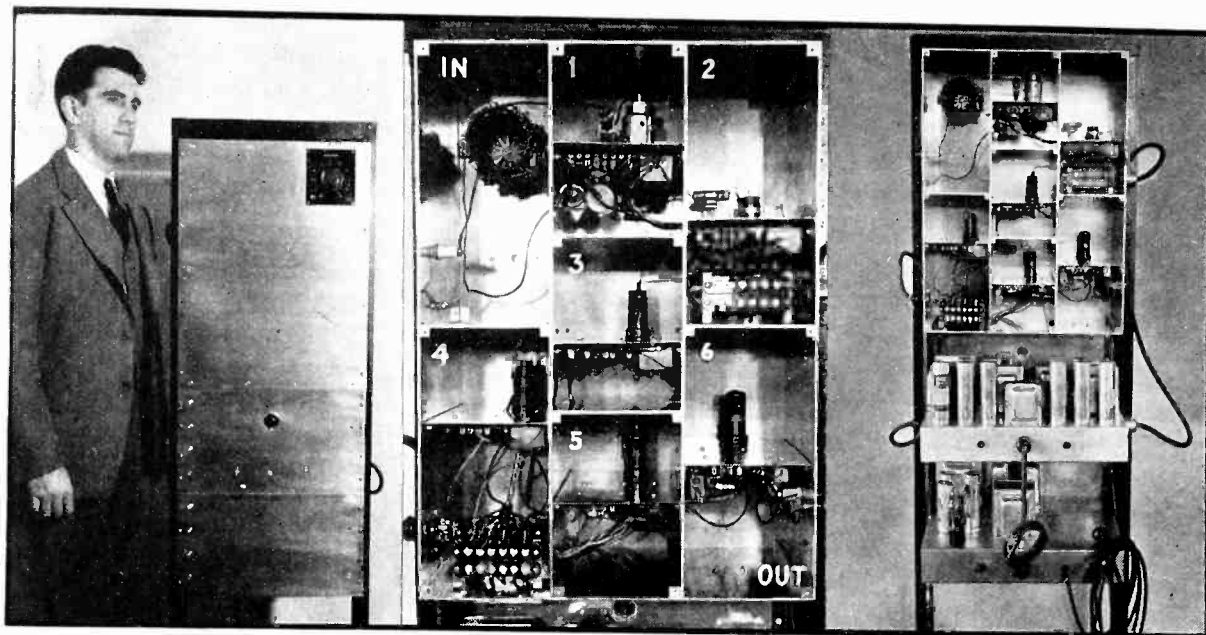

Fig. 2 — Inset shows the frequency response curve of the amplifier. Large set of curves indicate extent of distortion

Fig. 3 — Power output curves plotted as a function of the external load resistance for various values of input voltage





Left—Front view of relay rack mounted amplifier with Prof. Everest. Center—View into the interior of the amplifier, with input and output circuits labelled, and sequence of stages indicated. The staggered arrangement of stages is employed to reduce length of leads and minimize pick-up. Right—View of entire amplifier and power supply

age of the amplifier was measured with a vacuum-tube voltmeter which was flat to 500 kc and which was corrected to 4 megacycles. The capacitive loading of this voltmeter must, of course, be taken into account.

In the region of 300 kc a slight manifestation of a correction hump can be seen. This is due largely to the correction inductance applied to the output stage. The higher peak at 1.5 megacycles is caused by the correction of stage 5. A peak of this magnitude was retained to aid in compensation for the loss in high-frequency response due to the terminal apparatus which was to be connected to the amplifier.

The low-frequency response was easily measured by the usual audio amplifier technique. As mentioned before, the low-frequency response can be controlled within quite wide limits by the variation of the value of C_1 . If this condenser is made very large, the response will approach that of the broken line for the low-frequency region.

The broken line in the high-frequency region shows the response of the amplifier with all correction chokes removed. It is realized that there are many other methods of obtaining high-frequency correction, but the simplicity and directness of the inductance in the plate lead has much to recommend it.

While phase shift measurements were not made, these characteristics, if desired, can be quite easily calcu-

lated. Suffice it to say that all low and high-frequency corrections applied to this amplifier to aid the amplitude response, at the same time cause phase shift in a direction which tends to correct for the inherent phase shift of the amplifier.

The distortion characteristics were found by means of a General Radio harmonic analyzer with the amplifier being driven by a 1000-cycle signal.

Distortion

As expected for an unbalanced amplifier, the second harmonic content becomes quite high at the higher input signals as shown by Fig. 3. The use of single tube feedback minimizes harmonic distortion in all but stages 1 and 5. As the signals applied to stage 1 are very low, the amount of distortion arising in it is negligible. The greater part of the measured distortion was found in stage 5 which has no precautions for avoiding pentode distortion and which is also driven hard to supply sufficient driving voltage for the power output stage. Although 10% total harmonic distortion is not excessive for most laboratory uses, certain precision measurements may demand less. The distortion of the amplifier can be reduced to very low proportions by the use of feedback across the last two stages.

The magnitude of the power output which can be expected across various load resistances is shown in Fig. 4. The load resistance for these curves

is defined as that resistance which is placed across the output binding posts of the amplifier. The curves can also be used to find the output voltage which the amplifier will develop across various resistance loads for three values of input signals.

Gain Adjustment

Any of the ordinary methods of controlling the gain of audio-frequency amplifiers also influence the frequency response when applied to wide-band amplifiers. For this reason, this amplifier is being described as a constant-gain amplifier for assurance that the amplitude and phase response always remain the same. For a general laboratory wide-band amplifier, some method of controlling the gain is necessary. The only satisfactory answer is an input attenuator. The problem of designing a voltage-divider which will divide voltages of frequencies from 25 cycles to two million cycles per second is beyond the scope of this paper, but will be covered later.

The answer to the problem, however, is found in the use of a resistance divider and a capacitance divider in parallel. Very satisfactory results can be obtained from an attenuator of this type, although the initial adjustment is rather laborious without special equipment. This adjustment can be carried out in a very satisfactory manner, however, with the aid of an amplifier such as described and ordinary laboratory instruments.

The physical arrangement of the individual stages is shown. The level of the different stages is so adjusted that the plate lead of one tube will have a minimum length in running to the grid of the next stage. This naturally leads to a staggered arrangement. The input terminals pass to the special attenuator in the upper left compartment. The signal is then fed as shown. This type of arrangement is almost necessary for the 1851 type of tubes in which the grid cap comes out the top.

Many improvements in circuits, component parts, and physical arrangement could probably be made. For instance, the recent 1852 and 1231 types of television pentodes having the grid connection at the base open up the possibility of the use of the conventional chassis layout. On the whole, however, this amplifier has been very satisfactory and has been used in television research work.

"Voder's" keyboard, on which the operator builds words and sentences from their component sounds

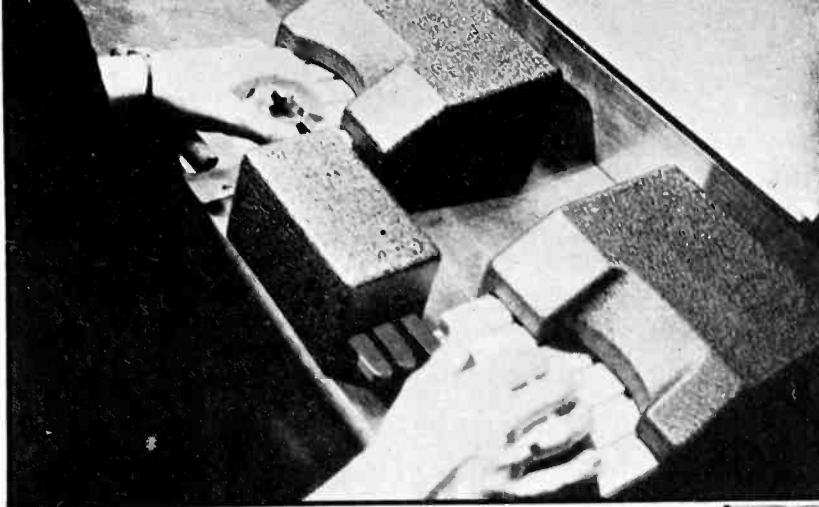

Below, equipment for producing synthetic speech, containing two noise generators, filters and attenuators

Synthetic Speech

Bell Lab's "Voder" employs tubes to generate basic speech sounds, and an operator to combine them into words

ON January 5th the Bell Telephone Laboratories demonstrated for the first time the formation of synthetic speech in complete sentences, when they revealed the "Voder" (voice operation demonstrator) at the Franklin Institute in Philadelphia. The Voder is an electronic instrument controlled by keys and capable, when manipulated by a skilled operator, of talking in any language, at any pitch level, and any desired loudness. The Voder differs from the phonograph, which simply reproduces the voice, in that it actually builds up speech from the basic constituent sounds made in the throat and mouth. The immediate practical use is simply as a demonstration device for the entertainment of visitors at the New York World's Fair and the San Francisco Golden Gate Exposition.

The electronic principle of the Voder is quite simple. Essentially, only two noise generators are employed. One reproduces the "hiss" sounds of the voice; it is a gas-filled tube which produces a fluctuation noise by essentially the same mechanism as the shot effect. The other generator is a relaxation oscillator which produces a saw-tooth wave, similar in shape to the waves produced by the vocal chords (the so-called "voiced" sounds). The outputs of both of these generators are very rich in harmonics, so much so in fact that the spectrum of each may be divided into bands, all of which have substantially the same harmonic

content. Thus it is possible to introduce changes in pitch in the hiss sound as well as the voiced sound, simply by passing the generator output through band-pass filters. Ten such band-pass filters are used, covering in ten overlapping bands the entire voice-frequency range included in the bass, tenor, alto and soprano voices. Each filter is selected by one of ten keys, and the attenuation introduced (hence the loudness of the resulting sounds) is controlled by the depth to which the keys are depressed. Thus ten frequency bands of hiss sounds and ten frequency bands of vowel (voiced) sounds are available at variable sound levels. Since the same keys are used for each type of sound, the selection of one type or the other is controlled by a wrist-operated switch. In addition three small black keys, operated by the right thumb give the stop-consonant sounds, known to phoneticists as "conjugate pairs": p and b for the first key, t and d for the second, and k and g for the third. Finally, a foot pedal is provided to raise and lower the fundamental frequency of the sawtooth wave generator, so that the changes in voice pitch normal to ordinary speech may be reproduced. This combination of manual and pedal controls makes it possible for a skilled operator to approximate the sounds of the human voice so closely that it is difficult to detect the difference between ordinary speech and the synthetic production. The output of the filters and attenuators is applied



to an ordinary public address amplifier and loudspeaker system.

The type of skill required to operate the device is evidenced by the fact that proficiency is obtained only after a year's practice, at 3 hours per day. One or two lessons suffice to form such simple words as "she saw", but to be able to say "Bell Telephone exhibit at the San Francisco Fair" is something else again. At the demonstration none in the audience was successful in stumping the operator, even with such words as "intercommunicability" and "comment allez-vous?". It is true that the device speaks with a "slight electrical accent", but its limitations appear to lie simply in the ability of the operator to analyze the sounds she hears into their component parts, and her manual dexterity in reproducing the succession of sounds with the required swiftness and smoothness.

Tube Equipment in Industry

A survey, presented in tabular form, of industrial electronic equipment now available from manufacturers. Intended to serve as a guide to the prospective user and purchaser of non-communication tube-operated devices, compiled from all sources known to *Electronics'* staff

TUBES have found their way into industry through two important channels: through the efforts of individual engineers who have designed their own equipment to meet their own particular problems, and through the sale of more or less complete equipment by organizations who specialize in development of tube-operated devices. To make available more information on the second of these two channels, the editors recently undertook to obtain as complete a list as possible of the manufacturing organizations who offer industrial electronic devices for sale. The result is the table shown opposite which lists some 40 manufacturers and 50 products cross-indexed by symbols which indicate in a general way the types of equipment available from each concern.

The table, which is as complete as possible, has been compiled with the following restrictions in mind: the products listed are complete equipments which use electron tubes for some other purpose than the communication of intelligence. For this reason component parts, radio and telephone equipment are not listed. Nor does the list contain equipment (such as cathode-ray oscillographs, tube testers, oscillators, etc.), which occasionally finds its way into industrial pursuits but whose main field of use is in communications. The names of the equipment listed contain some duplication (for example a densitometer may also be used as a transparency meter, and in some cases, vice versa), but in general the items listed perform widely varying functions.

To obtain the list of manufacturers several sources of information, including the subscription lists of *Electronics*, were employed. In all 117 manufacturers were circularized, and replies from over 50 were obtained. Those listed in the table represent replies on hand when the table was compiled. Several additions are listed

at the end of this page. It is virtually impossible to obtain a complete list, and for that reason, the editors request readers who have any connection with concerns in this field to write the editorial offices, giving the name and address of the firm, and if possible some of the particulars of the products made. This information will be kept on file, and published in a later issue.

The cooperation of the various manufacturers has been overwhelming. Over 100 photographs of different electronic devices were received, of which only 16 could be accommodated in the present article (see following pages). The remaining pictures are in the active file, and will be used in the "Tubes At Work" department as rapidly as space permits. Even more voluminous were the descriptive letters and bulletins accompanying the pictures (by actual weight, 15 pounds of "literature" was received). To attempt to put into a single article even a small part of this material would result in meager descriptions, unfair to the reader and to the manufacturer alike. In consequence, no attempt has been made to describe any particular manufacturer's products, their purposes or virtues.

In place of particularized descriptions, a comprehensive table of industrial electronic equipment functions has been prepared to allow the reader to see at a glance the nature of the tasks to which electron tubes are now applied. Three groups have been set up: electronic measuring instruments; electronic process controls; and electronic safeguards and alarm devices. The usual name for the apparatus which performs a function within each group has been stated, together with brief descriptions of the electronic principles involved and the fields in which the devices are used. Of necessity not every device and function in the field has been

listed, owing either to limitations of space or the ignorance or forgetfulness of the compiler. The editors welcome comments, additions, and suggestions for changes in emphasis from all interested persons.

A few general conclusions may be drawn from the manufacturer-vs-product table shown opposite. One is the amazing variety of devices actually available from several of the concerns, large and small alike. Phototubes continue to serve the majority of the control and measurement functions, but the capacity-operated relay is increasing in importance, largely due to the research in recent months which has established the limits within which these devices may be used reliably.

The combination of the two tables, showing electronic functions in one, and the manufacturers of devices to perform these functions in the other may prove helpful in orienting the prospective industrial users of tubes in the field. If the problem is one of measurement, control, or supervision, and if it coincides with a function listed in any of these groups, electron tubes may help to solve the problem, and an inquiry to the manufacturers of the particular device may reveal at once whether tubes are the answer or whether it must be sought elsewhere. It is hoped that the compilation will prove helpful in bringing closer together the prospective users of tube equipment and manufacturers.

In addition to the manufacturers listed in the table, the following list should be consulted: Allis-Chalmers Manufacturing Co., power rectifiers. Central Scientific Co., pH concentration indicators, phototube relays, rectifiers, regulated rectifiers. Geophysical Instrument Co., metal detectors. Illinois Testing Laboratories, Inc., capacity-operated relays, metal detectors. Rubicon Company, welding controls and recorders. Will Corporation, pH concentration meters.

Industrial Electronic Devices and their Functions

GROUP 1

MEASUREMENT

Meters and gauges used to measure physical and chemical quantities. Direct-reading scale instruments. Separately-calibrated scale instruments. Comparison (sample-vs-standard) instruments.

QUANTITY MEASURED	NAME OF DEVICE	ELECTRONIC PRINCIPLE	PRINCIPAL FIELDS OF USE
Acoustic intensity	Sound Level Meter Sound Analyzer Vibration Meter Vibration Analyzer	Electronic amplification of microphone or vibration pick-up current	Machine development. Architecture. Civil noise control. Testing materials.
Color	Colorimeter Color Comparator Color Analyzer	Generation of photoelectric current in phototube or phototube; amplification	Paint, pigment, and printing ink industries. Biology. Textile and paper industries.
Current (electric)	Electrometer	High-input resistance tube for measuring voltage across resistance developed by current	Insulation testing. Astronomy. General laboratory practice.
Density (optical)	Densitometer Microdensitometer	Measurement of light attenuation by phototube or photocell; amplification	Photography. Astronomy. Spectroscopy.
Frequency (electric)	Frequency meter Frequency standard	Resonant circuit, oscillation and amplification. Piezo oscillation and amplification	High frequency engineering. Exact standards of time. Astronomy. General Laboratory practice.
Humidity	Humidometer	Measurement of capacitance change in resonant circuit containing humidified article as dielectric	Paper-making and textile industries.
Light intensity	Photometer Illumination meter	Generation of photoelectric current in phototube or photocell; amplification	Photography. Lamp development. Illumination engineering.
Number	Electronic counters	Actuation of light-operated or capacity operated relay by counted object	General factory practice, conveyors, packing, etc. Cosmic ray studies. Traffic surveys.
pH concentration (hydrogen ions)	pH meter Titration meter	Measurement of high resistance between electrodes	General chemical research, development, and factory practice.
Pressure (of gases)	Pressure indicator	Measurement of capacitance change in resonant circuit containing pressure-element	Engine development. Ballistics.
Reflection (optical)	Reflectometer	Photoelectric comparison of light reflected from sample and standard surfaces	Paints. Paper. Textiles. Metal platin.
Resistance (electric)	Wheatstone bridge (electronic)	Use of electron tube in one or two arms of bridge for high resistance measurement	General electrical laboratory practice. High resistance measurements.
Rotation-reciprocation	Stroboscope	Control by thyratron, of current pulses through electronic lamp	Machine development. Photography. General mechanical laboratory practice.
Temperature	Optical pyrometer	Measurement of color temperature by photoelectric means	Steel and alloy research and production. General laboratory practice. Lamp development.
Thickness	Electronic thickness gauge	Electronic contact indicator with penetration gauge. Inductive measurement in magnetic gauge	Paint and other coatings.
Time	Electronic timers	Measurement of charge accumulation on capacitor, by v-t voltmeter	Traffic controls and survey. General mechanical engineering and factory practice.
Transparency (optical)	Transometer	Photoelectric measurement of light attenuation of transparent object	Paper and textile industries.
Turbidity	Turbidity meter	Photoelectric measurement of light attenuating power of turbid liquid	Chemical processing. Water works.

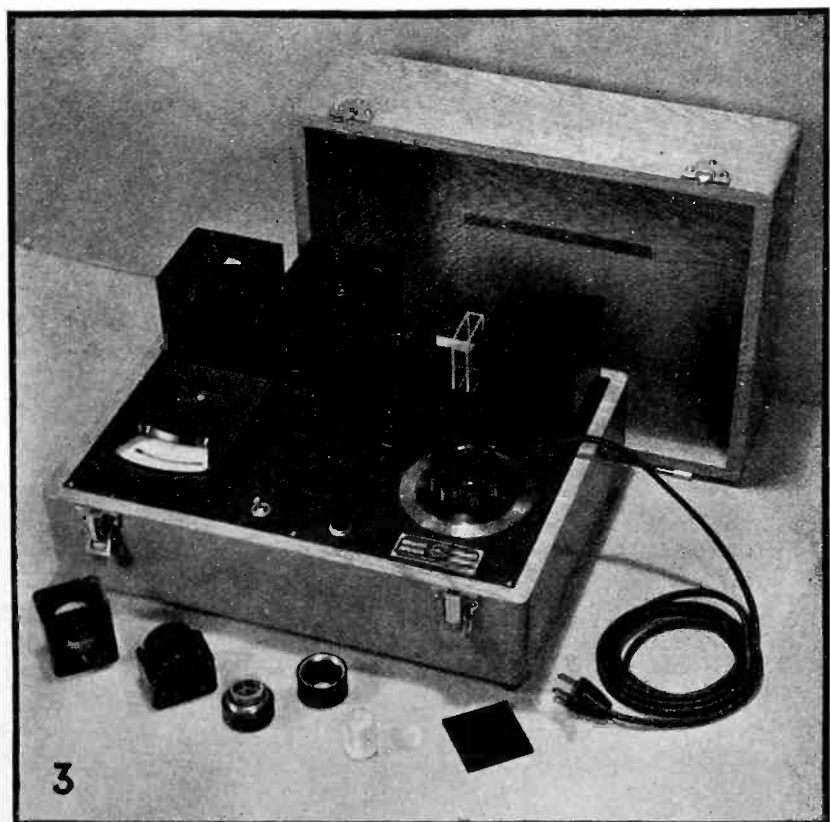
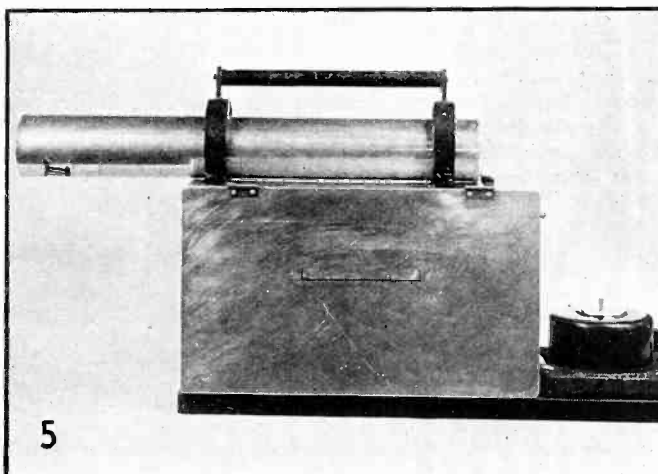
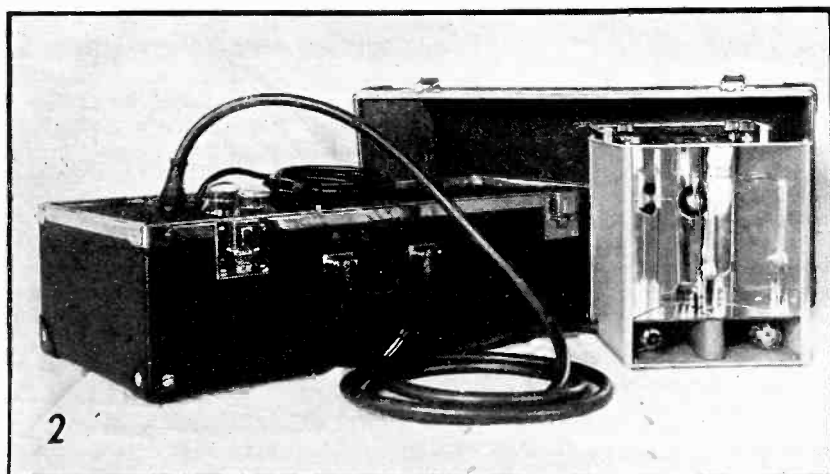
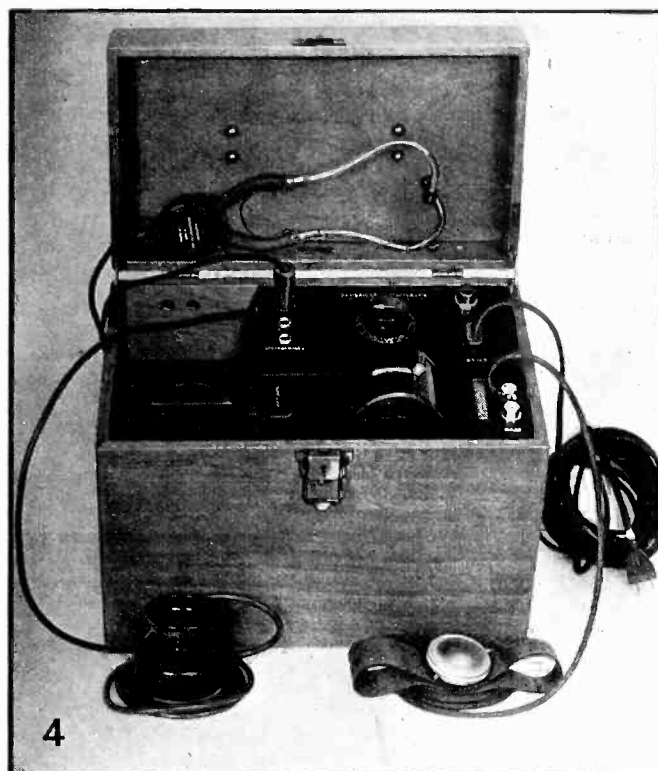
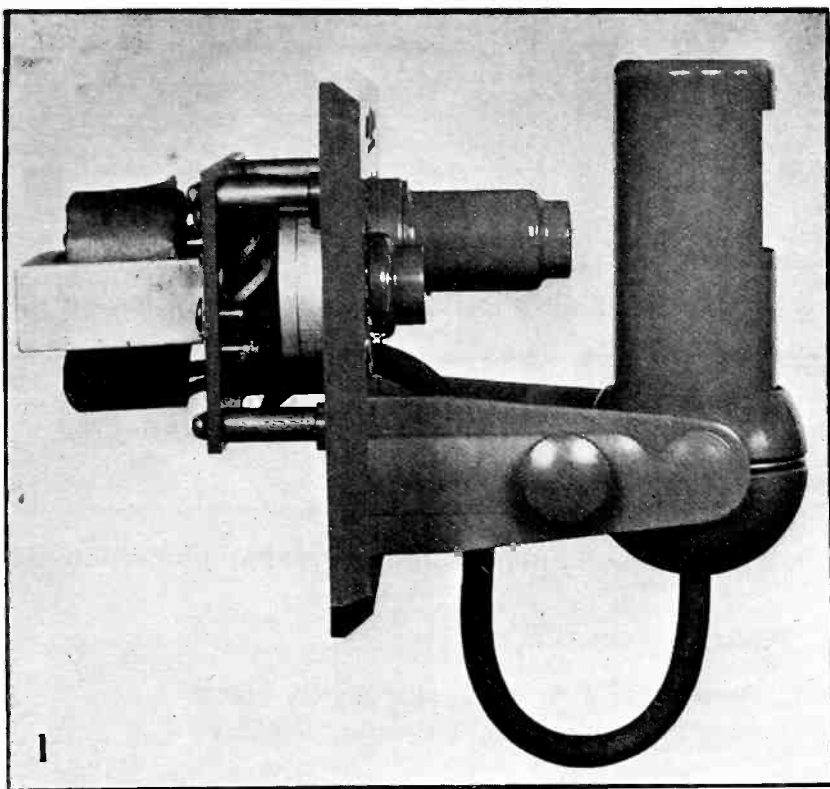

- 1 Useful for the measurement or control of illumination is this neatly designed General Electric lighting control unit. Note the two metal tubes, painted to harmonize with the bracket and phototube housing
- 2 The Stroboglow, a Westinghouse version of the stroboscope, which permits studies of the motions of rotating or reciprocating objects. An electronic (gas-filled) lamp in the housing is controlled by a tube "valve" circuit
- 3 A portable laboratory colorimeter, a product of the Luxtrol Company. The glass cell (rear) holds liquids whose color is analyzed in terms of three filters applied to the lamp
- 4 Cambridge Instrument Company's Stethograph, a recording oscillograph especially designed for diagnosing diseases of the heart. It contains a low-frequency amplifier which drives a galvanometer recording element
- 5 For measuring the intensity of cosmic rays, this Geiger counter has been developed by the Geophysical Instrument Company. A gas-filled tube, just on the point of conduction, passes current when the impact of a cosmic ray ionizes the gas within the tube

INDUSTRIAL ELECTRONIC DEVICES AND THEIR FUNCTIONS (Continued)

Velocity	Speed indicator	Use of electronic timer actuated by controls a known distance apart	Athletic contests. Motor and horse racing. General mechanical engineering and factory practice.
Voltage	Vacuum-tube voltmeter	Use of tube in high impedance circuit. Rectification of high frequency voltage by diode	High frequency engineering. General laboratory practice.
Waveform	Oscilloscope	Use of cathode-ray tube with associated amplifiers	Noise and vibration studies. General electrical laboratory practice.

GROUP 2



PROCESS CONTROL

Devices for controlling, automatically or semi-automatically, some quantity in mechanical, electric, chemical, etc. processing industries.

PROCESS OR QUANTITY CONTROLLED	NAME OF DEVICE	ELECTRONIC PRINCIPLE	PRINCIPAL FIELDS OF USE
General (application to any measuring device whose indication is in the form of current or voltage, including all devices listed in Group 1)	Controlling potentiometer Meter-and-phototube relay	Relays actuated by phototube and amplifier; light source interrupted by meter pointer or automatic potentiometer mechanism	Wherever measurements listed in Group 1 must be used for automatic control of quantity measured. See Fields of Use listed in Group 1
Air supply	Electronic precipitator	Rectification at high voltage to attract charged dust particles	Air-conditioning in public places. Control of atmosphere in general industrial processing.
Balancing and weighing	Phototube weighing control	Control of phototube relay by motion of weighing-machine pointer	General.
Batching and packaging by bulk	Phototube batching control	Control of phototube relay as batched material intercepts light beam	General.
Casting testing	Acoustic pitch tester	Sound analyzer (Group 1) sorts casting by pitch emitted when struck by hammer	Automotive parts.
Combustion-ignition	Ionization ignition control	Tube measures conductivity between housing and flame tip, to monitor flame	Oil burners. Gas burners.
Conveyor control	Phototube conveyor control	Objects on conveyor actuate phototube relay according to size, color, position, etc.	General factory practice.
Counting	Phototube counter Capacity-operated counter	Actuation of relays by counted object (capacity relay used with metal objects only)	General factory, packaging, and shipping.
Flaw detection	Magnetic inspector	Inductive or resonant circuit inspects magnetic material for change in permeability	Metal processing (iron and steel only).
Grading by color	Phototube color separator	Combination of one or more phototubes and filters actuating sorting relays	General. Egg, fruit, and vegetable packing.
Illumination	Illumination control	One or more phototube relays control lamps as illumination changes	Schools, offices, factories. Photographic processing.
Liquid level	Liquid-level control	Phototube relay or capacity-operated relay actuated by opaque or conducting liquid	Chemical processing. Steam engineering. Sewage works.
Metal detection	Metal detector	Resonant circuit inspects material for sources of eddy-current loss	Prisons. Milk processing. Food packaging.
Motion limits	Phototube or capacity operated limit relay	Phototube or capacity operated relay actuated by object exceeding normal limit of motion	Automatic machine tools.
Perforation	Pin-hole detector	Phototubes inspect sheet for perforations admitting light	Sheet metal manufacture.

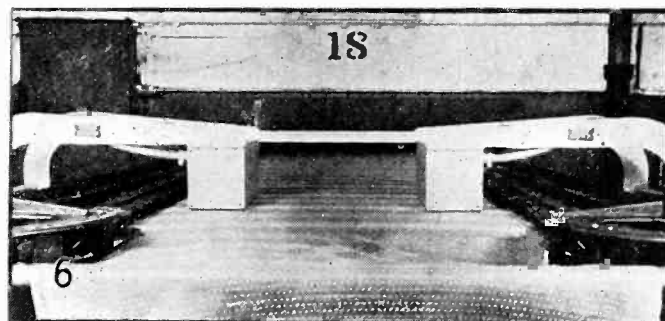
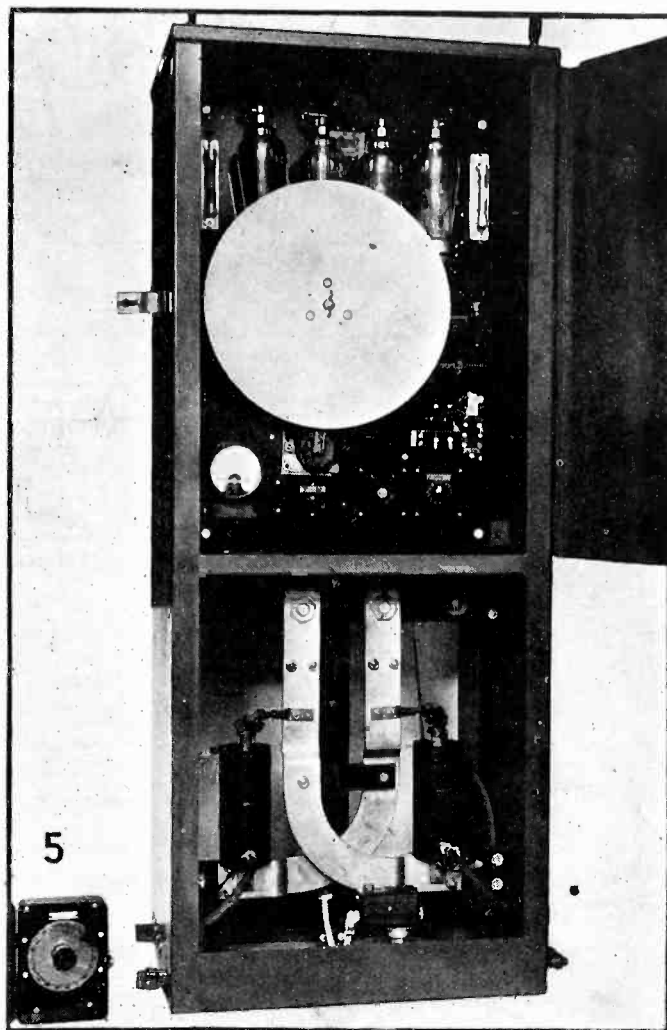
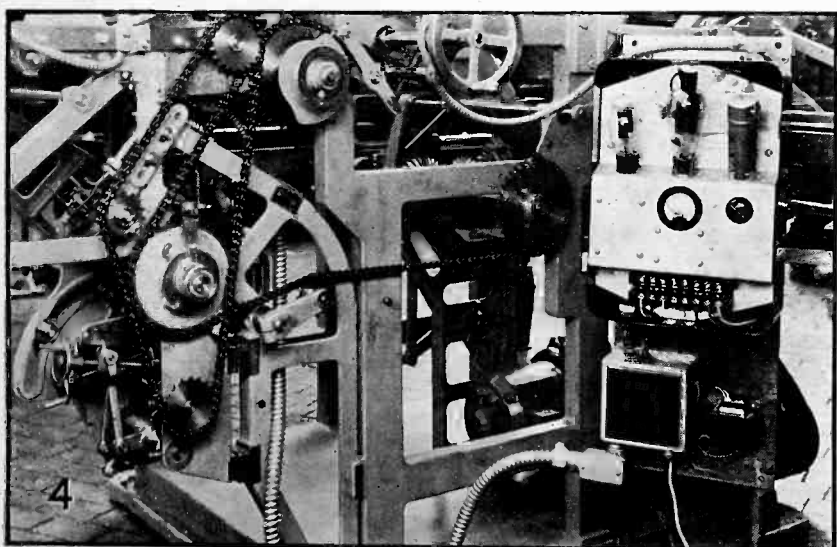
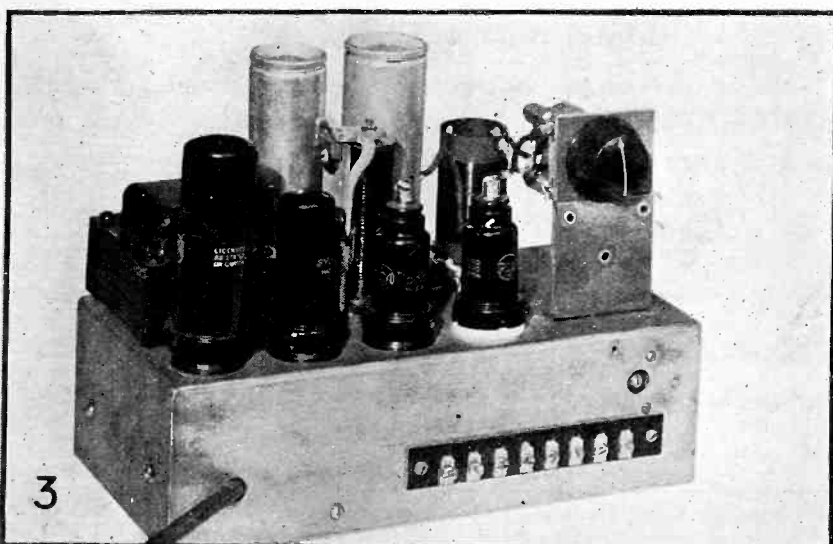
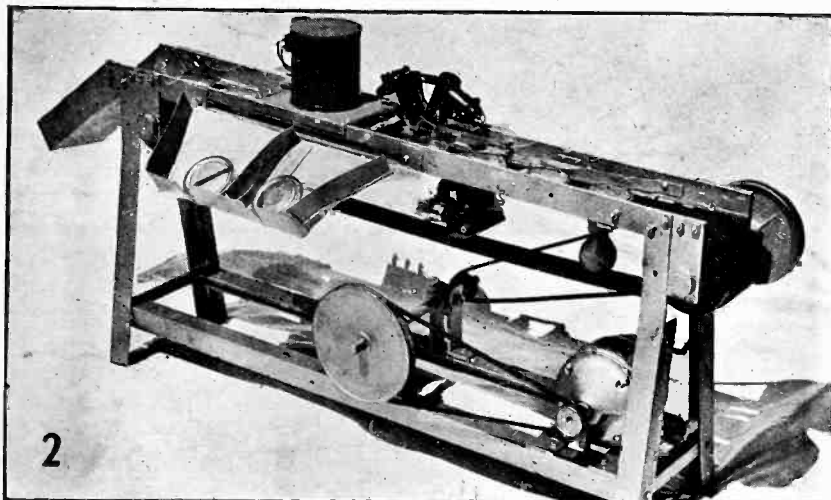
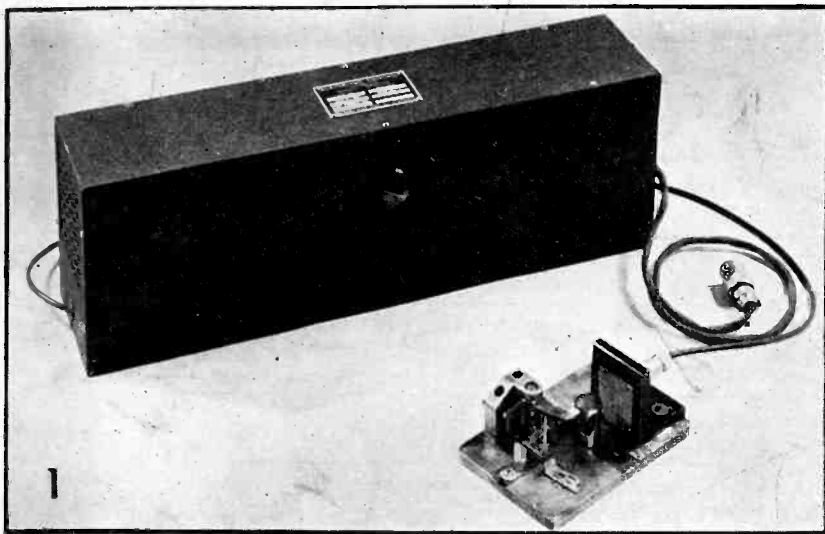

- 1 An acoustic casting tester, designed by Electronic Control Corp. A hammer strikes the casting (before microphone, foreground), causing it to ring. If the ring falls within specific pitch limits, the casting is acceptable; otherwise it is rejected
- 2 This device automatically inspects the covers of tin cans for improper coating, and rejects imperfect specimens. Made by the Electronic Products Company
- 3 The capacity operated relay is second only to the phototube as a control device. This unit is a product of the United Cinephone Corporation
- 4 The Package Machinery Company uses a phototube register control on its wrapping machinery. At the left is the thyatron panel which controls the register drive
- 5 A complete resistance welding control panel produced by Westinghouse. In the upper section are the thyatron control tubes; below the water-cooled ignitron conduction tubes
- 6 A typical example of continuous process control, the automatic weft-straightening phototube scanner of the General Electric Co. applied to a cloth straightening machine

INDUSTRIAL ELECTRONIC DEVICES AND THEIR FUNCTIONS (Continued)

Process recording	Recording potentiometer	Phototube relay actuates potentiometer balancing element	General industrial processing of critical nature requiring automatic record.
Register	Register control	Phototube views printing or register marks; relay corrects deviations by actuating guides	Food and candy packaging. Automatic printing.
Regulation (electric)	Electronic voltage or current regulators	Vacuum or gas-filled tubes used to regulate resistance of supply circuit in terms of load. Control of generator field excitation	General electrical practice.
Resistance heating	Phototube heat control	Phototube views charge and controls power in terms of color temperature	Metal fabrication.
Skew control	Photoelectric skew control	Phototube monitor views fabric threads relative to stationary guide	Weaving.
Smoke	Phototube smoke control	Phototube relay actuated by presence of smoke between it and light source	Combustion engineering.
Temperature	Thermocouple with meter-and-phototube relay (see also Group I)	Low impedance thermocouple connected to control relay by meter pointer actuating phototube relay	Metal manufacture. Chemical processing. Ceramics, plastics.
Welding (resistance type)	Electronic welding timers	Ignitron or thyratron tubes control duration of current through weld	Automobiles, refrigerators, etc. General metal fabrication.

GROUP 3

SAFEGUARDS AND ALARMS

Devices which give warning of improper operation in fabrication and processing, or which indicate when a measured quantity exceeds set limits. Devices for protection against industrial hazards. Devices for protection of goods and property.

TYPE OF PROTECTION	NAME OF DEVICE	ELECTRONIC PRINCIPLE	PRINCIPAL FIELDS OF USE
General: any device listed in Groups I or II may be fitted with alarm (lamp, bell, horn, etc.)	Calibrated relay	Employs trigger circuit to close or open relay when set limits are exceeded	General (see Groups I and II)
Burglar	Infra-red Phototube Relay Capacity Operated Relay	Interception of invisible beam (infra-red) or presence of body capacity actuates relay controlling alarm	Stores, homes, factories. Exhibitions. General protection purposes.
Combustion	Ionization-type flame monitor	Tube measures conductivity of ion path in flame. Turns off fuel if flame fails, actuates alarm	General combustion practice: oil, gas, powdered coal, etc.
Door-opening	Phototube door opener Capacity door opener	Interception of light or body capacity actuates pneumatic door control	Restaurants, railroad stations, traffic control in crowded public places.
Fire	Phototube smoke alarm	Partial interception of light monitoring ventilation ducts, etc. to detect smoke from fire	Ships, warehouses, etc.
Flood	Liquid level control and automatic signal	Float in water reservoir controls contactor which signals level to alarm circuit	Important rivers and streams.
Mercury-vapor	Ultra-violet phototube absorption alarm	Mercury light source illuminates phototube. Presence of vapor absorbs part of light actuating relay and alarm	Industries employing mercury or mercurous compounds.
Punch-press	Phototube punch-press control	Worker intercepts "curtain" of light, actuates relay which prevents closing of press	General heavy machinery. General protection against industrial hazards.

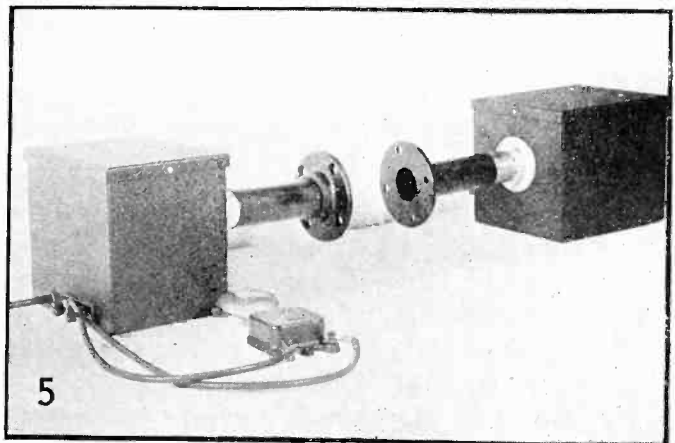
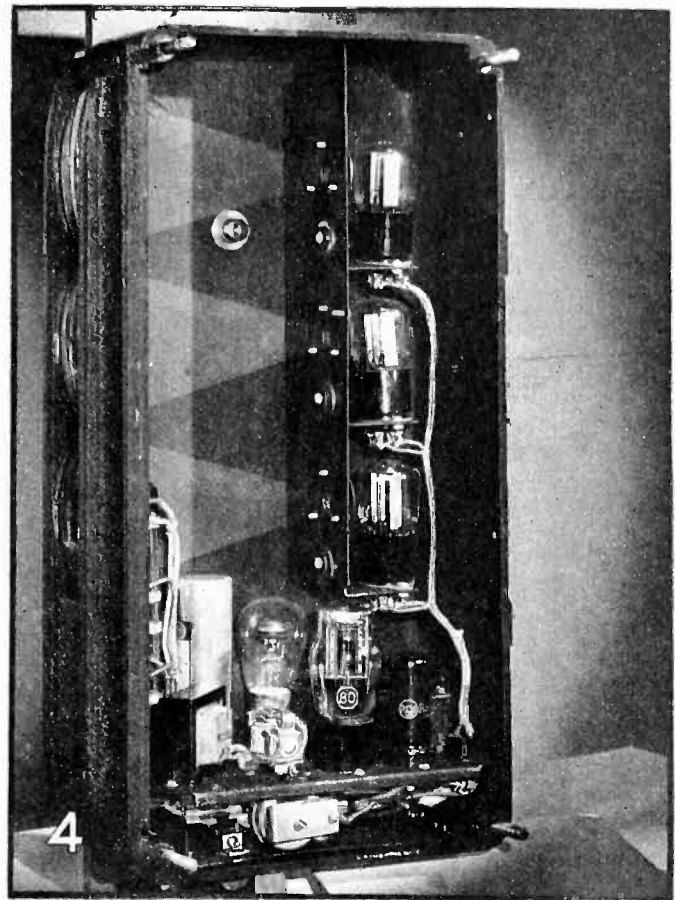
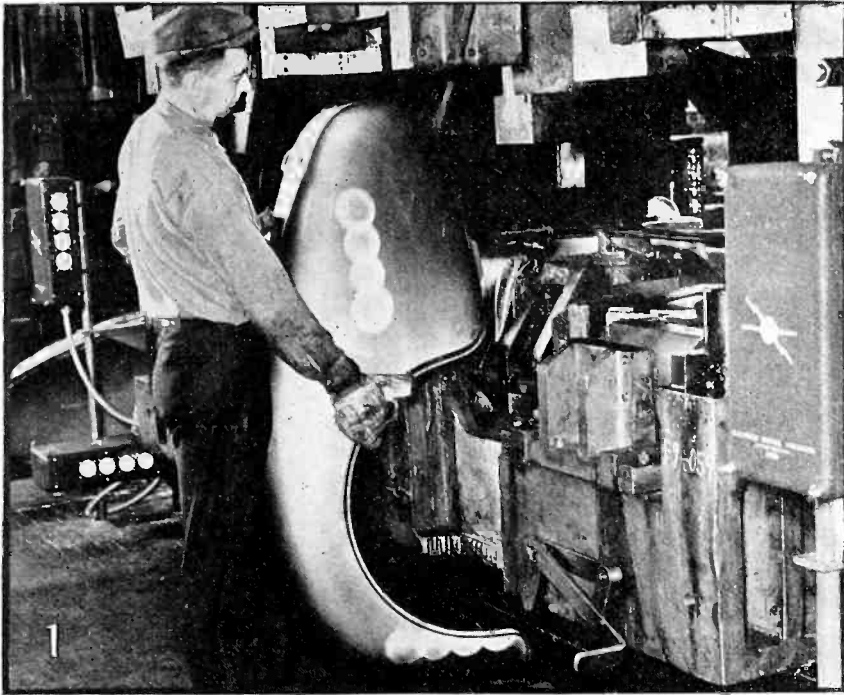

1 A typical punch-press control, installed in an auto body plant by Electronic Control Corp. The curtain of light (see circles of light on fender) prevents operation of the press when intercepted

2 Conveyor control, either for safety purposes or otherwise, is an important industrial use of phototubes. Above is a Photobell Corporation unit

3 A metal detector used in penal institutions is this "mattress frisker" developed by the Illinois Testing Laboratories. It operates on the search-coil principle

4 The light receiving unit of the punch-press control. The lenses focus light on the phototubes which operate in series. If any part of the beam is interrupted, no photoelectric current flows

5 The basic element of the smoke alarm unit offered by Associated Research, Inc. Useful for combustion control or fire alarm service

A New "VI" and

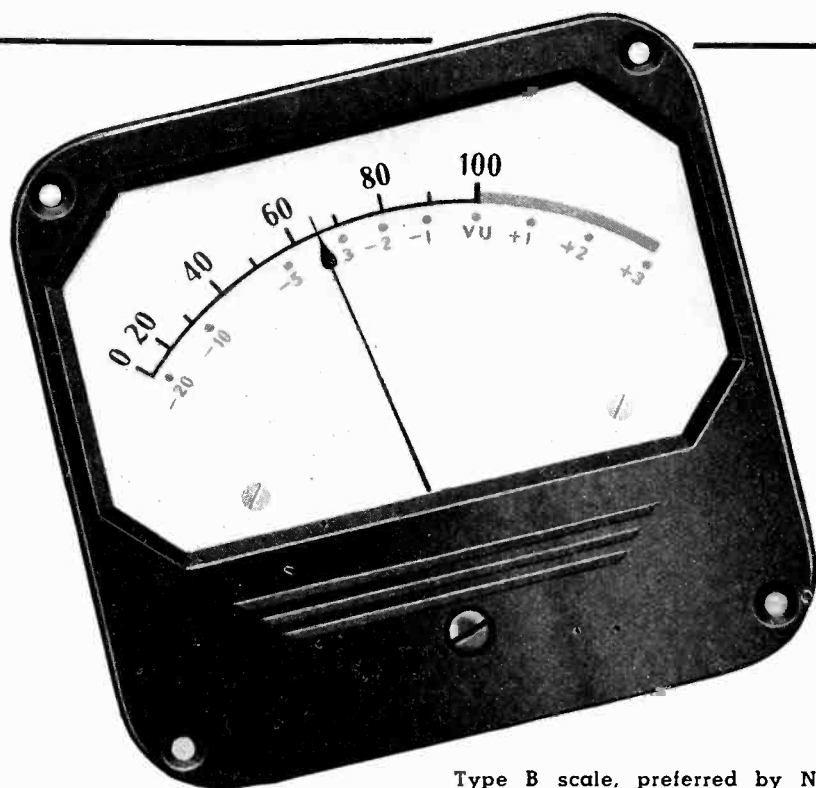

Type B scale, preferred by NBC and CBS is intended for program production and transmission applications. Meter case is $4\frac{1}{4}$ in. wide and 4 in. high

H. A. AFFEL HOWARD A. CHINN ROBERT M. MORRIS
Bell Telephone Laboratories Columbia Broadcasting System National Broadcasting Co.

ON DECEMBER 16, 1938, an announcement was made by the Bell Telephone Laboratories, the Columbia Broadcasting System and the National Broadcasting Company that agreement had been reached upon a new standard volume indicator instrument and a new standard reference level. The design of the new volume indicator meter was fixed upon after much consideration and many tests. It is a simple, comparatively inexpensive, copper-oxide rectifier type of meter, having carefully determined dynamic, electrical and other characteristics so chosen as to make the instrument readable over long periods with a minimum of eye strain or fatigue. It is designed to have a response to the rapidly varying program waves which is a satisfactory compromise between the ideals for each of the purposes for which a volume indicator is used.

The new standard reference level was announced in the following words:

Zero or reference volume level shall be defined by specifying (a) the characteristics and method of use of the volume indicator instru-

ment, and (b) a steady state reference of 1 milliwatt. The impedance of the circuit across which the instrument is calibrated shall be 600 ohms. The characteristics of the instrument as well as the value of the calibrating power are important features of the definition.

In order to avoid the more cumbersome term "db above zero volume level" and confusion with several existing standards, it is proposed to designate the readings of the new instrument as so many "vu", numerically equal to the number of db above the reference volume level.

At the present time, there are a wide variety of volume level indicators* in use throughout the communications industry. These differ in such characteristics as: Whether

* Volume level indicators are not to be confused with power-level indicators since the former are intended for the measurement of program material involving speech, music, etc., whereas the latter should be limited to the measurement of steady-state "sine-wave" power. This latter measurement is not, obviously, influenced by the ballistic characteristics of the instrument employed. Since sine-wave power is considered a form of program material, it is evident that a volume level indicator is also capable of power-level measurements but not vice versa.

the instrument is r-m-s or peak reading; slow, medium or high speed; half or full-wave rectifying; critically or lightly damped; or whether the reference level used for calibration is 1, 6, 10, $12\frac{1}{2}$ or 50 milliwatts in 500 or 600 ohms. These conditions have led to widespread confusion and misunderstanding in the communications industry, particularly when an attempt is made to correlate the measurements and results of one group with those of another.

To avoid this confusion, the above organizations have proposed for standardization the new instrument and the new standard reference level. It is hoped that the new instrument and the advantages of standardization will be sufficiently attractive for general acceptance. During the course of the investigation of the new volume indicator and its reference level, a number of informal meetings were held for the purpose of demonstrating the improved instrument to other organizations. One of these conferences was held on June 2, 1938, and another on June 17, 1938, at the IRE annual convention in New York. A total of 27 organizations concerned with the broadcasting industry in the United States and Canada were represented at the two meetings.

At these conferences, approval of the new meter was expressed, and it was agreed that the originating group should determine on a generally acceptable reference level for volume measurement. The Bell System companies, the National Broadcasting Company, and the Columbia Broadcasting System are looking forward to the adoption of the new in-

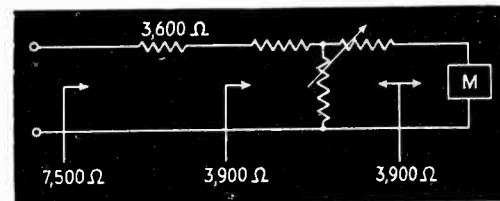

Schematic wiring diagram of the new volume indicator meter. Meter impedance is 3900 ohms and must be used with an external resistance of 3600 ohms to obtain desired ballistic characteristics. The impedance of the complete instrument is 7500 ohms

Reference Level

struments in their plants, together with the new reference volume level on May 1, 1939.

The scope of the present article does not permit a detailed account of the fundamental considerations and the tests which led to the design of the new volume indicator. It is planned, however, to publish this information at a later date.

1. The instrument employs a full-wave, copper-oxide rectifier contained within the meter case.

2. The ballistic characteristic is such that the sudden application of a single frequency voltage of such value as to give a steady state reading at 0 vu or 100 mark will cause the pointer to overswing by 1 to 1½ per cent (0.1 to 0.15 vu). The pointer speed is such that under the same conditions, a deflection of 99 per cent of the steady state value is reached 0.3 second after the sudden application of the single frequency voltage. This characteristic is in agreement with the C.C.I.F. recommendations.

3. The scale card is a cream yellow and has markings in black and red. Two scale types are available as indicated in the illustrations.

4. The meter sensitivity is uniform to within 0.2 db of the 1000 cps value over the frequency range from 35 to 10,000 cps and within 0.5 db over the range from 25 to 16,000 cps.

5. The instrument is capable of withstanding, for at least 0.5 second without injury or effect on calibration, voltage peaks of ten times the value equivalent to a reading of 100 per cent or zero vu. It is capable of withstanding a continuous overload of five times the 100 per cent or zero vu voltage.

As now available, the instrument itself has an impedance of 3900 ohms and *must* be used in series with an external resistance of 3600 ohms in order to have the required ballistic characteristics. The instrument with the series resistance has a sensitivity such that the pointer is deflected to the 0 vu or 100 mark on either program material or single frequency power having a volume level of +4 vu. For reading high levels, a variable 3900-ohm attenuator may be in-

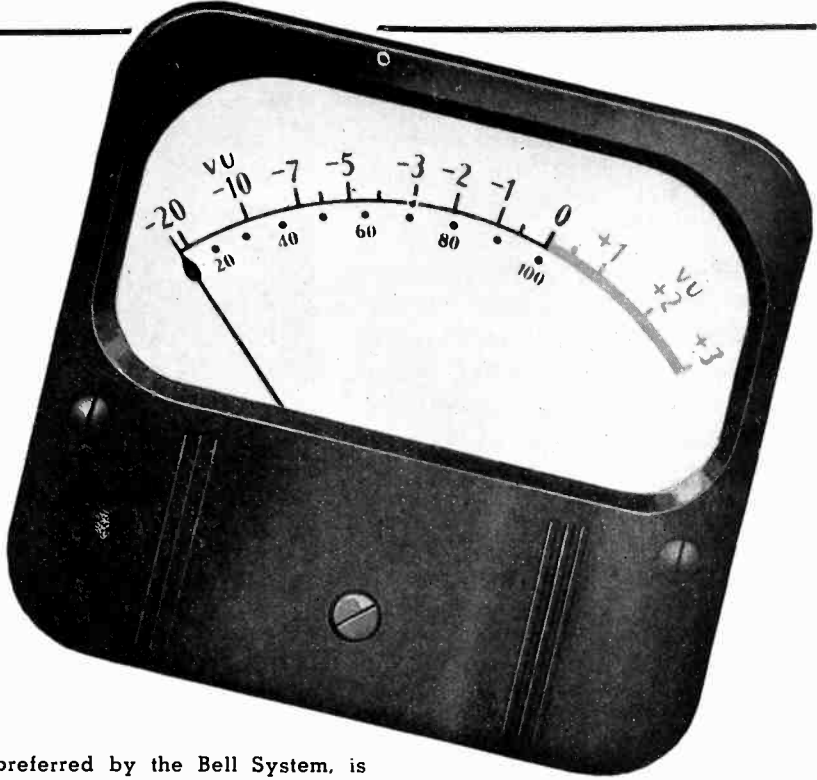

Type A scale, preferred by the Bell System, is intended for use in program transmission. The illustration is approximately three-fourths full size. Scales are from Weston type 30 volume indicator

serted between the meter and the external resistance to decrease the meter sensitivity. The meter must not be placed in close proximity to magnetic materials and must therefore not be mounted on magnetic panels.

The adoption of 1 milliwatt as the calibration of the new reference volume was decided upon because (a) it is a simple decimal number of convenient magnitude, (b) it is related to 1 watt by the "preferred" factor of 10^{-3} , (c) it corresponds to the value of testing power used for transmission measurements on program circuits, and (d) it was found to be the one value to which general agreement is possible. A survey indicated that adoption of a 600-ohm standard impedance would meet with the most ready acceptance throughout the communications field. It also appeared to be most favorable for international adoption.

The adoption of the new terminology for expressing volume readings made with the new instrument is considered an important part of the standardization. It should be borne in mind that volume expressed in "vu" implies a measurement of absolute volume level. It indicates that the measurement was made with the new standard instrument. Most pre-

vious types of volume indicators, even though recalibrated to a 1 milliwatt basis, will not give indications on program material corresponding to those of the new instrument.

There has in the past been considerable controversy over whether a volume indicator should be of the r-m-s or peak reading type. As a result of the tests which were made, it was found that there was only a minor difference between the peak type and the r-m-s instrument of the design finally determined upon. The significance of this difference disappears when volume limiting amplifiers are employed. On the other hand, the change in wave shape which occurs in transmission over lines of any length, even after phase correction has been applied, may make it impossible to check readings with peak reading types of instruments, whereas the r-m-s instrument is not affected. These facts, together with other considerations, led to the adoption of the r-m-s type of instrument.

It is to be hoped that the new volume level indicator with the new standards of calibration and terminology will be adopted generally by the communications industry in this country, and that they may receive international recognition.

An Ultra-High-Frequency Power

By ANDREW V. HAEFF

Research and Engineering Department
RCA Mfg. Co.,
Harrison, N. J.

FOR many high-frequency applications a non-regenerative power amplifier is of primary importance. It is the purpose of this paper to describe an amplifier of a novel type with which successful operation is obtained at frequencies much higher than those which can be handled by conventional devices of comparable power capabilities.

Some of the principal difficulties encountered in the operation of amplifiers at very high frequencies can be ascribed to the following causes.

1. The finite electron transit time resulting in excessive input loading and a loss in transconductance.
2. Abnormally high coupling between the output electrode and input electrode causing either regeneration or excessive loading of the output circuit by the reflected input losses with a consequent loss of power and efficiency.
3. High circulating currents and increased resistance at high frequencies lowering circuit efficiency.

In the new amplifier the electron-transit-time effects are minimized by utilizing electrons of high velocity. This is accomplished without increased dissipation and loss in efficiency by separating the functions of the output electrode and of the current-collecting electrode and by making use of electron focusing. The output-input coupling is reduced to a negligible value by screening and separation of the respective electrodes and circuits. The high-frequency losses due to circulating currents are minimized by using current-carrying electrodes of large periphery.

The principle used in exciting the output tank circuit of the new amplifier differs from that of conventional tubes. Figure 1 represents a quarter-wave concentric tank circuit with a hollow inner conductor. Let us suppose that a negatively charged body is passed through the inner conductor from left to right. In Fig. 1a we see

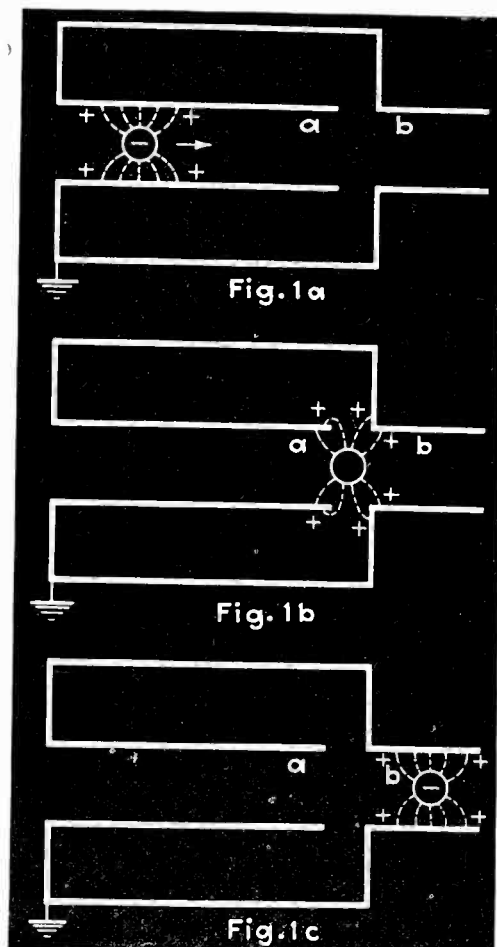

Fig. 1—Diagram showing changes in distribution of image charge as a charged particle moves inside the quarter-wave tank circuit

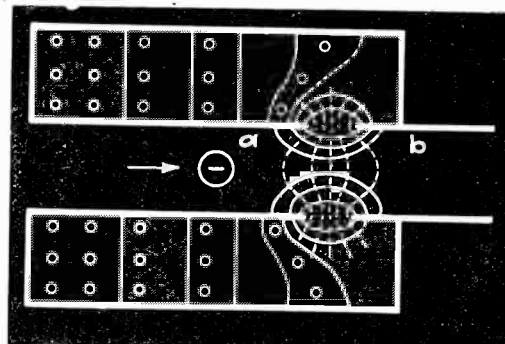

Fig. 2—Distribution of fields inside resonating space of tank circuits; fields do not penetrate inside the inner conductor, a, or the aperture extension, b

the conditions of charge distribution on the circuit as the body is introduced into the inner conductor. There is a positive charge, equal to the negative charge, induced on the inside of the inner conductor near the body. However, no charge appears on the outer surface of the inner conductor. The induced charge moves with the charged body along the inner surface until the end of the inner conductor

is reached. During the passage of the charged body across the gap $a-b$ the charge is partially imaged on the end of the inner conductor and partially on the outer conductor as shown in Fig. 1b. The passage of the charged body beyond the gap $a-b$ into the aperture in the outer conductor causes all of the induced charge to appear on the inner surface of the extension of the aperture (Fig. 1c). The induced charge, in transferring from the end of the inner conductor to the aperture extension, flows back over the outer surface of the inner conductor, thus constituting a current flow in the tank circuit.

Figure 2 illustrates the configuration of the electric and magnetic fields within the resonating space of the tank circuit when the latter is excited. The solid lines represent the electric field distribution and the circles represent the magnetic lines of force. The dashed lines represent the equipotential surfaces in the gap. Along the major part of the length of the tank the direction of the electric field is substantially radial. However, at the gap $a-b$ the electric field has an axial component. The field does not penetrate very far inside the open end of the inner conductor or inside the aperture in the outer conductor but is confined effectively to the space defined approximately by the limiting equipotential lines shown in the figure. The space inside the inner conductor and inside the extension of the aperture is essentially field free. Therefore, no work will be done on a charge moving inside the inner conductor by the electric field until the charge reaches the gap $a-b$. If the charge traverses the gap at the instant when the electric force is in the direction from b to a , the charge will be decelerated, its energy being given up to the tank circuit. A charge crossing the gap during the opposite half cycle when the field is reversed will be accelerated, absorbing energy from the circuit. If the number of charges traversing the gap during the first half cycle is greater than during the second, the net effect will be that energy is supplied to the tank circuit.

Amplifier of Novel Design . . .

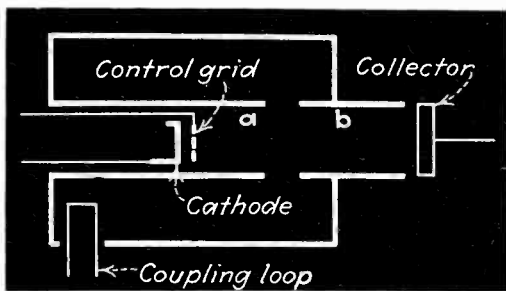

Fig. 3—A schematic diagram illustrating the arrangement of electrodes for exciting the tank circuit by modulated electron stream

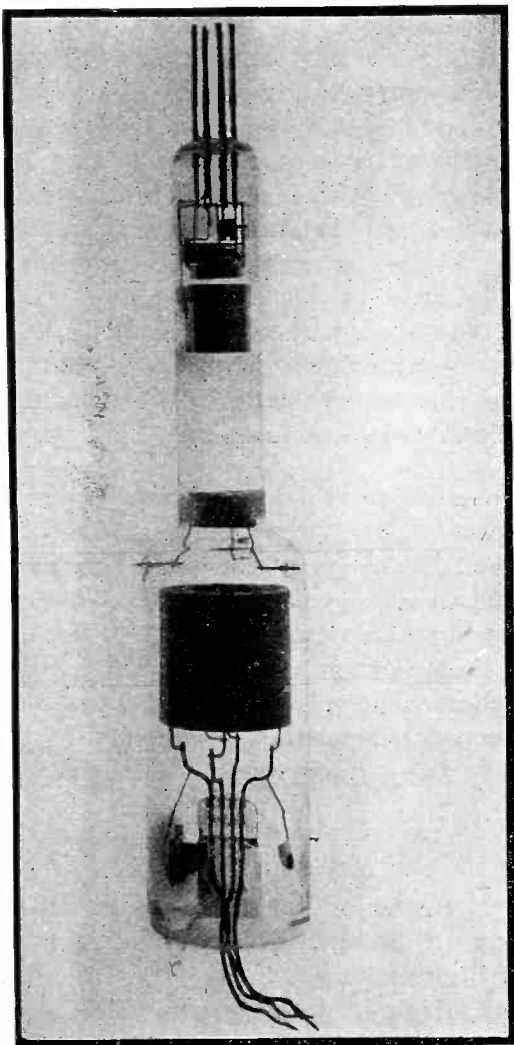

Fig. 5—Photograph of new type of tube in developmental stage

We conclude, then, that the tank circuit may be excited by passing groups of electrons at the proper frequency across the gap between the inner conductor and the outer conductor. The motion of electrons through the interior of the inner conductor has no effect on the current in the tank circuit. Also, high-frequency electromagnetic fields which will be generated within the resonating

space of the tank circuit penetrate but a short distance inside the screening electrode *b*, so that the electrons will be influenced by these fields only during their passage across the gap.

Figure 3 shows schematically how a tube may be combined with the tank circuit to operate on this principle. A conventional grid-cathode structure may be used to obtain pulses of electrons. A collector electrode may be placed beyond the screening electrode. If a high potential is applied between the cathode and the electrodes *a*, *b*, and also between the collector and the cathode, a stream of electrons from the cathode will flow towards the collector. If a high-frequency voltage is applied between the control grid and the cathode, the electron stream will be periodically modulated in intensity. Pulses of

be such as to decelerate electrons traversing the gap during the half period of maximum intensity of electron current in the stream.

The energy lost by the electrons is transformed by the tank circuit into the energy of the electromagnetic field within the space between the inner and outer conductors. This energy is then transferred to the useful load by means of a coupling loop, as shown in Fig. 3.

The high-frequency electromagnetic field existing in the resonant space of the tank circuit penetrates only a short distance inside the cylinder *a* and inside the screening electrode *b*. Therefore, by positioning the control electrode and the collector at suitable distances from the gap *a-b*, the coupling between the output circuit and the respective electrodes

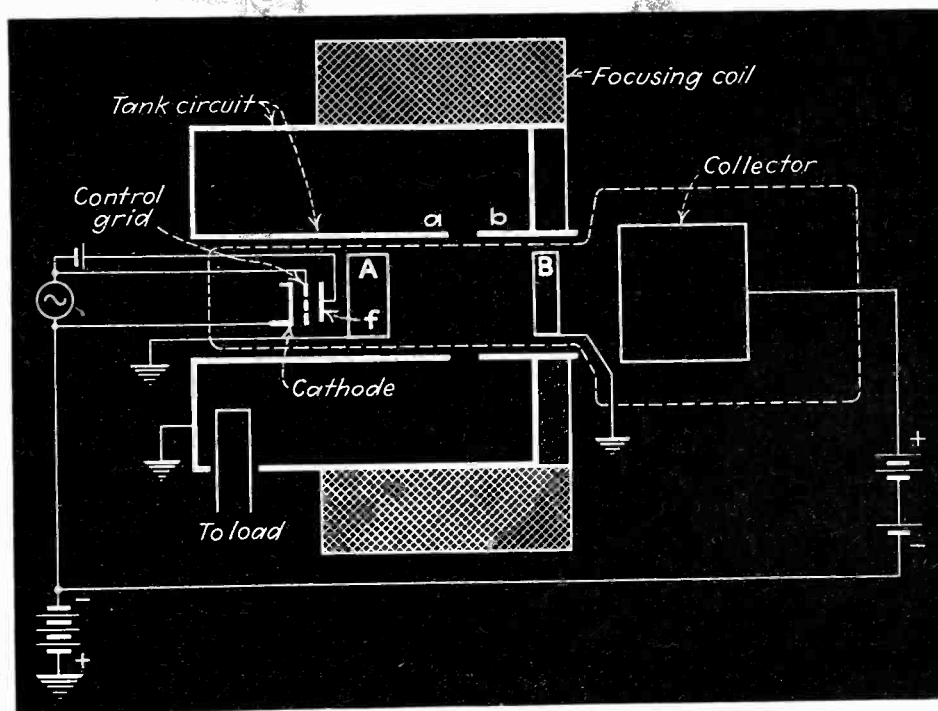

Fig. 4—Complete schematic wiring diagram of the amplifier and new tube with all essential parts indicated

electrons traversing the gap *a-b* will induce high-frequency currents between electrodes *a* and *b*. If the excitation frequency is adjusted to the resonant frequency of the tank circuit, a high impedance will exist across the gap *a-b* at this frequency. Consequently, the induced currents will produce a high radio-frequency voltage across the gap. The phase of this voltage at or near resonance will

can be reduced to a negligible value.

To minimize the transit-time effects the electrodes *a* and *b* can be operated at suitably high potentials with respect to the cathode. The adjustment of these potentials is not at all critical because the functioning of the tube does not depend critically upon the electron transit time. The current-collecting electrode can be operated at a much lower potential

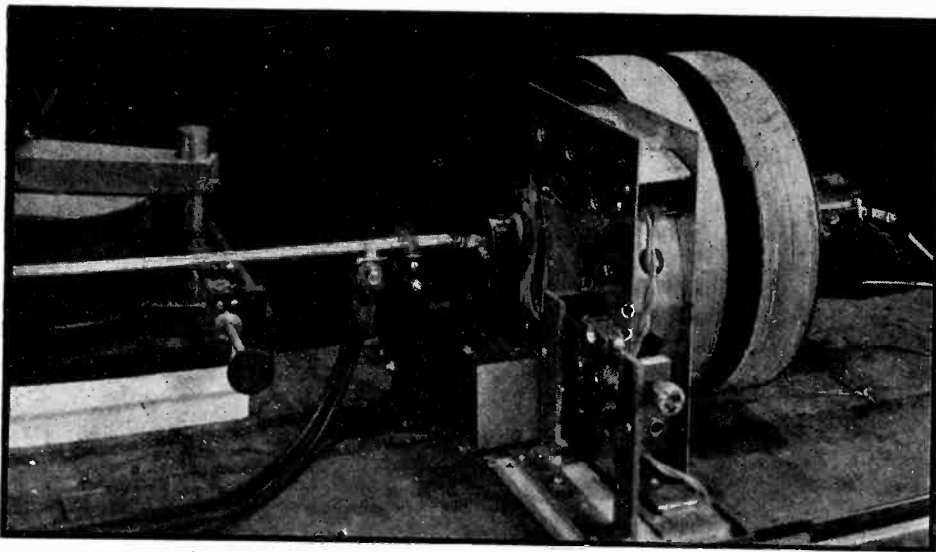

Fig. 6—The completed amplifier showing, from left to right, the driving magnetron, the input circuit, the housing for the load lamps, and focussing coils and the collector end of the tube

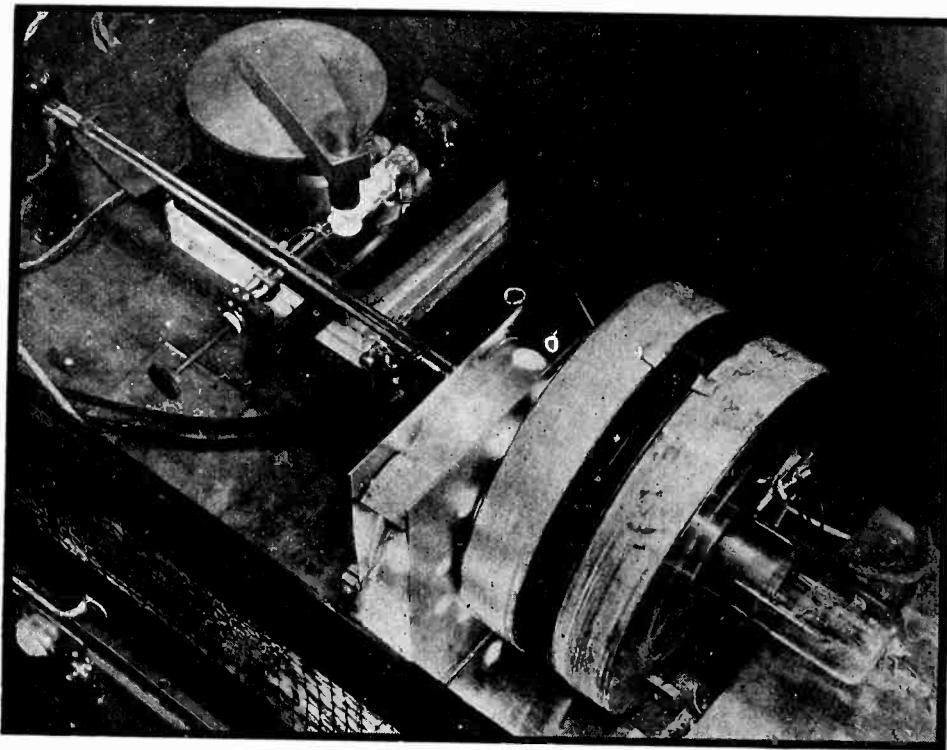

Fig. 7—The u-h-f amplifier in operation, and brilliantly lighting the incandescent lamp load circuit, contained in the lamp housing adjacent to the focussing coil

and is usually operated at a potential just sufficient to collect all decelerated electrons in order to obtain high efficiency. By the use of electrostatic or magnetic focusing the electron stream can be prevented from impinging on the high-potential electrodes *a* and *b*. Therefore, these electrodes do not dissipate energy. It follows that all of the power developed by the tube is taken from the low-voltage supply used for the collector.

Figure 4 shows schematically one complete arrangement. A focusing electrode *f* and accelerating electrodes *A* and *B* are mounted inside the glass envelope in addition to the cathode, the control grid, and the collector of the previous arrangement. The output tank circuit, consisting of the

outer cylinder, a hollow inner conductor, and a screening electrode, is separate from the tube. A solenoid placed around the tank circuits produces a focusing magnetic field in the axial direction. The focusing electrode, *f*, when operated at a suitable potential serves to concentrate the electron stream at the start and makes it possible to use a considerably weaker magnetic focusing field without absorption of current by the accelerating electrodes. The reason for using accelerating electrodes inside the glass envelope is to avoid the undesirable effects of charges on the glass walls due to bombardment by stray electrons. These electrodes are positioned at a suitable distance from the gap *a-b* of the output tank circuit so that the

high-frequency electromagnetic field from the resonant space of the tank does not reach them. Thus, these electrodes are not a part of the output circuit and do not carry circulating currents.

Figure 6 shows this tube mounted in the circuit. In this arrangement a small magnetron was used as a driving oscillator. The photograph shows the magnetron with its tuning mechanism, the parallel-wire input line, and a push-pull voltmeter which was used for measurements of driving power. The load consisted of eight incandescent lamps, fed in parallel from the coupling loop and mounted in a shielded compartment to prevent radiation losses and coupling to the input line. Fine adjustment of load was obtained by moving the load coupling loop with a micrometer screw. Behind the focusing solenoids the collector end of the tube can be seen. Figure 7 shows the tube in operation with the load lamps brilliantly lighted and visible through the observation openings.

As an example of performance of the new amplifier, the following data for the developmental tube shown in Fig. 5 may be of interest.

Operating frequency....	450 megacycles
Power output.....	110 watts
Total driving power (approx.)	.10 watts
Efficiency (approx.).....	35%
Accelerating voltage.....	6000 volts
Collector voltage.....	2000 volts
Collector current.....	150 milliamperes
Current to accelerating electrodes—	less than 0.1 milliampere

We may summarize the advantages of the new amplifier as follows:

1. Reduction of electron-transit-time effects by utilization of electrons of high velocity.
2. High efficiency due to collection of electrons at low velocity.
3. High power output because the collector may be made of adequate size without influencing the performance of output circuit.
4. Non-regenerative amplification through reduction of output-input coupling to a negligible value.
5. Low circuit losses because circulating currents flow in electrodes of large periphery.

The author wishes to acknowledge the valuable help of Dr. L. S. Nergaard in making measurements in connection with this work.

Design for Exponential Horns of Square Cross Section

THE sides of an exponential horn are commonly cut from sheet metal, the layout being effected with the aid of a cardboard template. The projected view of one side, bent into shape for assembly, is shown in Fig. 1. If the elevation view were flattened out to lie in a plane, its appearance would be identical to that of the template.

For any distance x on the horn axis there is a corresponding length of template, L , and a corresponding template width, $2y$. Hence, if we derive the expressions $y=f_1(x)$ and $L=f_2(x)$, we can determine the template width and length in terms of the x dimension.

The cross sectional area of an exponential horn, at any point on the axis, A_x , is given by

$$A_x = A_o \epsilon B^x \quad (1)$$

in which A_o is the area at the throat of the horn, B is the flare constant, and x is the distance from the throat of the horn. If the horn is of square cross section, then

$$A_x = (2y)^2 \quad (2)$$

and to obtain the relation between x and y we substitute Eq. (2) into Eq. (1), obtaining

$$y = \frac{\sqrt{A_o}}{2} \epsilon^{\frac{Bx}{2}} = k \epsilon^{bx} = f_1(x) \quad (3)$$

in which $k = A_o^{1/2}$, and $b = B/2$.

It now remains to determine $f_2(x)$, and this may be done by methods of the calculus. The general expression for the incremental length of the curve is

$$dL = [(dx)^2 + (dy)^2]^{\frac{1}{2}} \quad (4)$$

From Eq. (3) we find that $dy = bk \epsilon^{bx} dx$, and consequently the length of the horn template is given by

$$L = \int [1 + b^2 k^2 \epsilon^{2bx}]^{\frac{1}{2}} dx. \quad (5)$$

By making the proper substitutions and simplifications, it can be shown that the solution of Eq. (5) is

By GEORGE H. LOGAN

Sound Department
M.G.M. Studio
Culver City, California

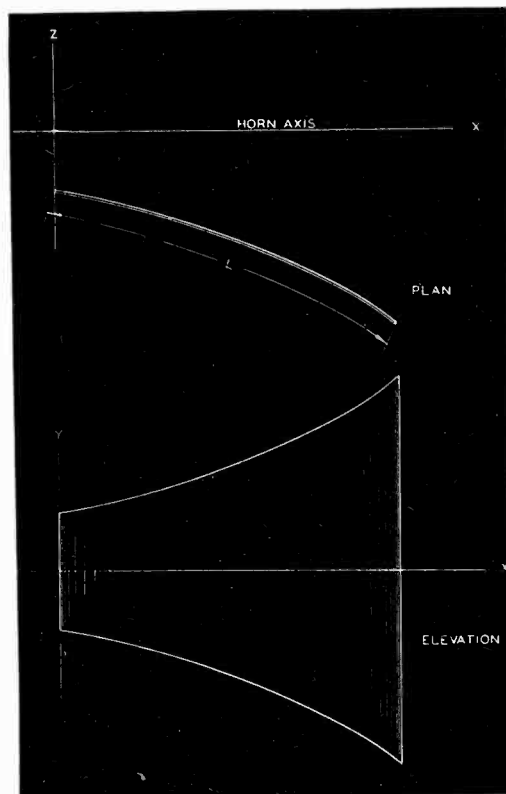

Fig. 1—Side view and elevation of one side of exponential horn of square cross section

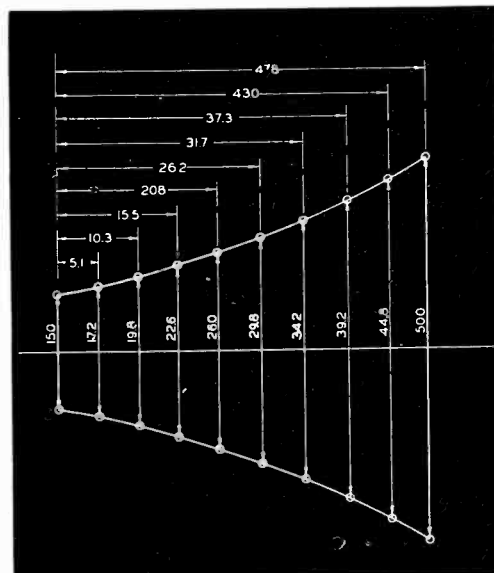

Fig. 2—Template for exponential horn of square cross section, laid out in accordance with the equations derived in this article

$$L = \frac{1}{b} \left[U + 1.1513 \log_{10} \left\{ \frac{(U-1)}{(U+1)} \right\} \right] - \frac{1}{b} \left[u + 1.1513 \log_{10} \left\{ \frac{(u-1)}{(u+1)} \right\} \right] = f_2(x) \quad (6)$$

in which $U = (1 + b^2 k^2 \epsilon^{2bx})^{\frac{1}{2}}$, and $u = (1 + b^2 k^2)^{\frac{1}{2}}$.

Thus, Eq. (3) and Eq. (6) give the width and length relations, respectively, corresponding to any abscissa, x , on the horn axis for an exponential horn of square cross section. The use of these equations in the making of suitable templates, can best be illustrated by means of an example.

For a particular type of horn, the design constants were, $k=7.5$, $b=0.0274$, and the maximum axial length was $x_{max}=44$ in. Substituting these values in Eq. (3) gives

$$y = 7.5 \epsilon^{0.274x}$$

where $\epsilon = 2,718$. . . The solution of this equation, which gives the semi-width of the mouth of the horn, is $y = \text{antilog}_{10} [\log_{10} (7.5) + (0.0274)(44) \log_{10} 2,718] = \text{antilog}_{10} 1.39866 = 25.0$ in.

Consequently, the width of the horn at the mouth is $2y$ or 50.0 in.

The overall length of the template, corresponding to x_{max} , is L_{max} and is given by Eq. (6). Using the constants specified, we find that $U = \sqrt{1.47039} = 1.2126$, and $u = \sqrt{1.0422} = 1.0208$. Therefore,

$$L_{max} = \frac{1}{0.0274} \left[1.2126 + 1.1513 \log_{10} \frac{0.2126}{2.2126} \right] - \frac{1}{0.0274} \left[1.0208 + 1.1513 \log_{10} \frac{0.0208}{2.0208} \right] = 1.569 + 46.255 = 47.8''.$$

In a similar manner progressive values of x between 0 and 44 in. are chosen, and the corresponding values of y and L are computed from Eq. (3) and Eq. (6). With a series of such values available, the template, Fig. 2, may be laid out.

Noise and Noise Measurement

By DANIEL SILVERMAN

A bibliography on the physiological effects of noise, the application of electrical instruments to the study of noise, and methods of correcting undesirable noise conditions

The Acoustical Basis of noise measuring instruments. The physiological effects of noise.

Abbott, E. J., Why Use Sound Meters? *Mechanical Engineering*, v. 55, 1933, 281.

Abbott, E. J., Scales for Sound Measurements Used in Machinery Noise Reduction, *J. A.S.A.*, v. 6, 1935, 137.

Churcher, B. G., Noise Measurements for Engineering Purposes, *Electrical Engineering*, v. 54, 1935, 55.

Churcher, B. G., A Loudness Scale for Industrial Noise Measurements, *J. A.S.A.*, v. 6, 1935, 216.

Chapin and Firestone, Influence of Phase on Quality and Loudness, *J. A.S.A.*, 1934, 173.

Davis, A. H., Noise, *Engineer*, v. 158, 1934, 166.

Fletcher, H., Proposed Standards for Noise Measurement, *Electrical Engineering*, Nov. 1933, 744.

Fletcher and Munson, Loudness, Its Definition, Measurement, and Calculation, *J. A.S.A.*, v. 5, 1934, 82.

Fletcher, H., Loudness, Pitch and Timbre of Musical Tones and Their Relation to the Intensity, Frequency, and the Overtone Structure, *J. A.S.A.*, v. 6, 1934, 59.

Fletcher, H., Loudness, Masking, and Their Relation to the Hearing Process and the Problem of Noise Measurement, *J. A.S.A.*, v. 9, 1938, 275.

Galt, R. H., Results of Noise Surveys. Part I, Noise Out of Doors, *J. A.S.A.*, v. 2, 1930, 30.

Geiger, P. H., and Abbott, E. J., Sound Measurement vs. Observers Judgment of Loudness, *Electrical Engineering*, December 1933, 809.

Ham, L. B., and Parkinson, J. S., Loudness and Intensity Relations, *J. A.S.A.*, v. 3, 1932, 511.

Hutchinson, Noise, *Inst. Mech. Engrs Proc.*, v. 13, 479.

Kingsbury, A Direct Comparison of the Loudness of Pure Tones, *Phys. Rev.*, v. 29, 1927, 588.

Knudsen, V. O., A.S.A. Committee has Broad Program for Measuring and Labeling Sounds, *Ind. Standardization and Comcl. Stds M.*, v. 7, Apr. 1936.

Laird and Coye, Psychological Measurements of Annoyance as Related to Pitch and Loudness, *J. A.S.A.*, v. 1, 1929, 158.

Laird, D. A., Effects of Noise, *J. A.S.A.*, v. 1, 1930, 256.

Mackenzie, D., Relative Sensitivity of the Ear at Different Levels of Loudness, *Phys. Rev.*, v. 20, 1922, 331.

Marvin, H. B., The Loudness of Noise, *J. A.S.A.*, Jan. 1932, 388.

McCurdy, R. S., Standardization of Noise Meters, *Electrical Engineering*, v. 54, 1935, 14.

McCurdy, R. S., Tentative Standards for Sound Level Meters, *Electrical Engineering*, v. 55, 1936, 260.

Muchow, A. J., Noise and Its Measurement, *G. E. Review*, v. 38, 1935, 293.

Obata, Morita, Hirose, and Matsumoto, Effects of Noise upon Human Efficiency, *J. A.S.A.*, v. 5, 1934, 255.

Parkinson, J. S., Results of Noise Surveys. Part IV, Noise Reduction, *J. A.S.A.*, v. 2, 1930, 63.

Riesz, R. R., Relationship Between Loudness and the Minimum Perceptible Increment of Intensity, *J. A.S.A.*, v. 4, 1933, 331.

Stanton, G. T., and Tweedale, J. E., Noise of the Rapid Transit Lines of New York City, *J. A.S.A.*, Jan. 1932, 377.

Steinberg, J. C., Relation Between the Loudness of a Sound and its Physical Stimulus, *Phys. Rev.*, 1925, 507.

Tucker, R. S., Results of Noise Surveys. Part II, Noise in Buildings, *J. A.S.A.*, v. 2, 1930, 68.

Wynne, S. W., New York City's Noise Abatement Commission, *J. A.S.A.*, v. 2, 1930, 12.

Proposed Standards for Noise Measurement. Report of the American Standards Association Committee on Acoustical Measurement and Terminology, *J. A.S.A.*, v. 5, 1933, 109.

American Tentative Standards of Noise Measurement, *Bulletin Z 24.2*, 1936, American Standards Association.

American Tentative Standards for Sound Level Meters for the Measurement of Noise and Other Sounds, *Bulletin Z 24.3*, 1936, American Standards Association.

Instrument for the Measurement and Analysis of Noise. Electrical Instruments Applied to the Study of Noise.

Abbott, E. J., Calibration of Condenser Microphone for Sound Meters, *J. A.S.A.*, v. 4, 1932, 235.

Anderson, C. A., Portable Sound Measurements, *Electronics*, v. 9, 1936, 26.

Ballantine, S., A Logarithmic Recorder for Frequency Response Measurements, *J. A.S.A.*, v. 5, 1935, 10.

Barrow, W. L., A New Electrical Method of Frequency Analysis, *Proc. I.R.E.*, v. 20, 1932, 1626.

Best, F. H., Decibel Meters, *Bell Lab. Record*, 1937, 167.

Castner, Dietze, Stanton, and Tucker, A Meter for the Analysis of Noise, *Trans. A.I.E.E.*, v. 50, 1931, 1041.

Davis, A. H., Measurement of Noise by Means of a Tuning Fork, *Nature*, v. 125, 1930, 48.

Davis, A. H., Measurement of Noise, *Engineering*, v. 138, 1934, 663.

Delsasso, L. P., A New Acoustic Analyzer, *J. A.S.A.*, v. 3, 1931.

Free, E. E., Practical Methods of Noise Measurement, *J. A.S.A.*, v. 2, 1930, 18.

Hall, H. H., A Magnetostriction Filter, *Proc. I.R.E.*, v. 21, 1933, 1328.

Hall, H. H., A Recording Analyzer for the Audio Frequency Range, *J. A.S.A.*, v. 7, 1935, 102.

Haynes, An Integrating Noise Meter, *Rev. of Sc. Inst.*, v. 6, 1935, 311.

Hickman, C. N., An Acoustic Spectrometer, *J. A.S.A.*, v. 6, 1934, 108.

Hunt, F. V., A Logarithmic Vacuum Tube Voltmeter, *Rev. of Sc. Inst.*, v. 4, 1933, 672.

Landen, A. G., An Analyzer for Complex Waves, *B. S. T. J.*, v. 6, 1927, 230.

Mead, M. S., and Berry, T. M., A Portable Frequency Analyzer, *G. E. Review*, v. 37, 1934, 378.

Meyer, A., A Method for Very Rapid Analysis of Sounds, *J. A.S.A.*, v. 7, 1935, 88.

Moore and Curtis, An Analyzer for the Voice Frequency Range, *B. S. T. J.*, v. 6, 1927, 217.

Muchow, A. J., A New Sound Level Meter, *G. E. Review*, v. 39, 1936, 293.

Nordenswan, R., A Modernized Hearing Meter, *Bell Lab. Record*, 1937, 163.

Norris, The Acoustimeter, *Projection Engineering*, v. 1, 1929, 43.

Olson and Kreuzer, A Reverberation Time Bridge, *J. A.S.A.*, v. 2, 1930, 78.

Oplinger, K. A., An Electric Ear, *Electric J.*, v. 28, 1931, 474.

Oshon, W. O., and Oplinger, K. A., A New Portable Meter for Noise Measurement and Analysis, *J. A.S.A.*, v. 5, 1935, 39.

Parkinson, J. S., The Ear as a Noise Measuring Instrument, *J. S.A.E.*, v. 39, 1936, 381.

Pierce, G. W., Magnetostriction Oscillators, *Proc. I.R.E.*, v. 17, 1929, 42.

Sabine, H. J., A Portable Reverberation Meter, *Electronics*, 1937, 31.

Schuck, O. H., The Sound Prism, *Proc. I.R.E.*, v. 22, 1934, 1295.

Scott, H. H., Commercial Noise Measurement, *G. R. Exp.*, v. 7, 1933, 6.

Stowel, E. Z., A Tuning Fork Audiometer, *J. A.S.A.*, v. 4, 1933, 344.

Theodoresen, T., A New Principle of Sound Frequency Analysis, *N.A.C.A., Tech. Report*, No. 395, 1931.

Waterfall, W., An Audiometric Method for Measuring Sound Insulation, *J. A.S.A.*, v. 1, 1930, 209.

Wegel and Moore, An Electrical Frequency Analyzer, *B. S. T. J.*, 1924, 299, *J. A.I.E.E.*, v. 43, 1924, 798.

Wente, E. E., Acoustical Instruments, *J. A.S.A.*, v. 7, 1935, 1.

Wente, Bedell, and Swartzel, The High Speed Level Recorder, *J. A.S.A.*, v. 4, 1935, 121.

Wente, E. E., Use of the High Speed Level Recorder in Determination of the Characteristics of Sound Transmission in Rooms, *J. A.S.A.*, v. 7, 1935, 123.

The Technique of Noise Measurement, *Bulletin 20*, General Radio Company, Cambridge, Mass.

Noise Measurement Methods, *Electronics*, 1935, 110.

Noise Symposium, *J. S.A.E.*, v. 34, 1934, 32.

Methods and Apparatus for Measuring the Noise Audiogram, *J. A.S.A.*, v. 1, 1929, 147.

The Application of Noise Measuring Instruments. The Correction of Undesirable Noise Conditions.

Abbott, E. J., Specifications of Power Noises, *Power*, v. 75, 1932, 537.

Abbott, E. J., Noise Specifications for Large Reduction Gears in Terms of Physical Units, *J. A.S.A.*, v. 3, 1932, 445.

Abbott, E. J., Noise in Refrigerators, *Electrical Refrigeration News*, v. 10, 1933, 10.

Abbott, E. J., The Place of Sound Measurements in Automotive Noise Reduction, *J. S.A.E.*, v. 35, 1934, 271.

Abbott, E. J., Quieting Substation Equipment, *Electrical Engineering*, v. 54, 1935, 20.

Abbott, E. J., Quieting Machinery, *Mechanical Engineering*, 1936, 713.

Abbott, E. J., The Role of Acoustical Measurements in Machinery Quieting, *J. A.S.A.*, October 1936.

Bedell and Swartzel, Reverberation Time, and Absorption Measurements with the High Speed Level Recorder, *J. A.S.A.*, v. 6, 1935, 130.

Chrysler and Snyder, Sound Transmission Through Building Materials, *Natl. Bur. Stds. J. Res.*, v. 2, 1929, 547.

Chrysler and Snyder, Sound Proofing of Airplane Cabins, *Bu. of Stds. Res. Paper* No. 63.

Cunnington, G. R., Practical Noise Treatment of Automobile Bodies, *J. S.A.E.*, v. 39, 1936, 388.

Davis, A. H., Silencing Aircraft, *Aeronautical Res. Com. Reports*, No. 1542, 1933.

Delsasso, L. P., Measurement of the Altitude and Inclination of Aircraft by the Echo Method, *J. A.S.A.*, v. 6, 1935, 1.

den Hartog, J. P., Vibrations in Industry, *J. of App. Phys.*, v. 8, 1937, 76.

Esval, O. E., and Frische, C. A., Dynamic Balancing of Small Gyroscope Rotors, *Electrical Engineering*, 1937, 729.

Firestone, F. A., The Technique of Sound Measurements, *J. S.A.E.*, v. 19, 1926, 461.

Firestone, F. A., and Abbott, E. J., Treatment and Diagnosis of Gear Noise, *Iron Age*, v. 134, 1934, 10.

Firestone, Burbin and Abbott, Reducing Noise of Machines, *Mechanical Engineering*, v. 54, 1934, 271.

Geiger, P. H., Noise in Heating and Ventilating, *Heating and Piping*, v. 8, 1936, 601.

Hall, A. W., Development of a Sound Isolation Base, *G. E. Review*, v. 36, 1933, 223.

Hansel, L. H., Vibration Isolation of Machinery, *Electrical Engineering*, 1937, 735.

Huber, P., Some Physical Problems in Noise Measurement, *J. App. Phys.*, v. 9, 1938, 452.

Johnson, W. E., Utility of Noise Meter in Quantity Production, *G. E. Review*, v. 37, 1934, 504.

Kaye, G. W. C., The Suppression of Noise, *Engineer*, v. 134, 1932, 432.

Kimball, A. L., Elimination of Noise in Machinery, *J. A.S.A.*, v. 2, 1930, 297.

Knudsen, V. O., Measurement and Calculation of Sound Insulation, *J. A.S.A.*, v. 2, 1932.

Marvin, H. B., Measurement of Machinery Noise, *Trans. A.I.E.E.*, v. 50, 1934, 1048.

McMahan, K. D., Noise Problems in the Application of Fans, *J. A.S.A.*, v. 7, 1936, 304.

Norris, R. F., Automotive Quieting, *J. A.S.A.*, v. 8, 1936, 100.

Parkinson, J. S. and Young, P. O., The Technique of Panel Damping Measurements, *J. A.S.A.*, April, 1936.

Snook, H. C., Automobile Noise Measurements, *J. S.A.E.*, v. 17, 1925, 115.

Spooner and Foltz, Study of Noise in Electrical Apparatus, *J. A.I.E.E.*, v. 48, 1929, 199.

Stanton, Schmid, and Brown, Reverberation Measurements in Auditoriums, *J. A.S.A.*, v. 6, 1934, 95.

Wolf and Sette, Some Applications of Acoustic Apparatus, *J. A.S.A.*, v. 6, 1935, 160.

Zand, S. J., Quiet within the Cabin, *Aviation*, April, 1933.

Zand, S. J., Noise Reduction in Cabin Planes, *Trans. A.S.M.E.*, v. 56, 1934, 49.

Development of Quiet Fans, *G. E. Review*, v. 37, 1934, 82.

Investigation of Airplane Mufflers, *Air Commerce Bulletin*, v. 4, December, 1932.

NEW BOOKS

The Radio Amateur's Handbook

BY HEADQUARTERS STAFF OF THE AMERICAN RADIO RELAY LEAGUE, Hartford, Conn. (454 pages plus 90 page catalog section. Illustrated. 16th ed., 1938. Price, \$1.00).

FROM A MODEST BEGINNING in November 1926 when 5,000 copies were hesitatingly printed to sales of more than half a million copies is the record of "The Radio Amateur's Handbook". The book is an elementary text on high frequency radio communication theory, deals with the construction and testing of radio equipment, outlines amateur radio as a hobby, and contains information enabling the prospective amateur to get started on his way to obtaining his licenses and operating his own station. Schools and technical classes have adopted the "Handbook" as a text; but most important of all it has become the right hand guide of practical amateurs in every country of the globe.

Among radio people the "Handbook" is so well known that a detailed review is certainly unnecessary. Let it suffice to say that the 16th edition, while similar to its immediate predecessors, has been brought up to date as regards current practice, is as compact, concise and precise as is possible to make such a book, and a better value than ever before.—B. D.

Police Communication Systems

By V. A. LEONARD. *University of California Press*. 1938. 589 pages, 20 illustrations. Price, \$5.00.

ALTHOUGH CURRENT INTEREST in police communication systems centers around radio methods, much more than this limited scope is dealt with in this new volume. From the time, about a century ago, when the man on the beat was completely out of touch with headquarters as soon as he left the office, up to the present time, when headquarters keeps in constant two way communication with its men, the history of police communication systems is thoroughly treated. Emphasis is placed on the communication system as an integrated and functioning unit, and its significance as regards safety, emergencies, and apprehension of criminals, rather than on the technical details of equipment design and operation. From this point of view the book appears to be intended more for the police executive who has to build up and maintain an effective communication system. But the text will also be interesting to the engineer who requires an understanding of the com-

plete operations of systems for which he is technically responsible.

Space is devoted to burglar and hold-up alarms, teletype networks, telephone systems, radio systems, and communication under disaster and emergency conditions. A chapter is devoted to a discussion of foreign systems now in use. Several appendices and an extensive bibliography are included. The book is interestingly and well written.

—B.D.

The Radio Manual

By GEORGE E. STERLING. *Engineering Department, Federal Communications Commission*. Third edition, 1938. 1100 pages. Price \$6.00. *D. Van Nostrand & Co., New York*.

THIS BOOK first published in 1928, has gone through numerous printings, and two previous editions. Gathering pages as it has gone along, it is now in the thousand-page class, containing material for operators, engineers, inspectors, data on radio aids to navigation, as well as fundamental theory, such as the section of electron tubes written by Robert S. Kruse.

Much of the material is descriptive, taken from manufacturer's literature. In this group may be found a great quantity of data on standard apparatus with code numbers given so that the student knows at all times exactly what he is reading about. Some 50 pages are devoted to marine auto-alarms; 90 pages to radio aids to air navigation, etc. Other chapters are devoted to broadcast transmitters, police radio equipment, measurement of antenna characteristics and field strengths, etc. A considerable space is devoted to FCC rules and regulations, extracts from the Communications Act

NEW B.B.C. CHIEF



Sir John Ogilvie, right, new chief of the British Broadcasting Corporation, inspects a video camera mounted on a truck, at the recent London Radio Show

of 1934, the recent Cairo Convention.

The book is an excellent manual of radio apparatus and its maintenance.

How to Pass Radio License Examinations

By CHARLES E. DREW. *RCA Institutes, New York City. John Wiley & Sons, Inc. New York, 1938. 200 pages. Price, \$2.00.*

THIS IS THE "how to pass book" that has aided many, many operators to get their tickets. There was once a time when all one had to do to pass the exams was to memorize this useful book, with the certainty that all of the questions on the examination would appear in this book, but that all of the questions answered in the book could not appear in any one exam.

That day has changed. The toughest job in the old days was to memorize the circuit diagram of a complete transmitter and receiver, and to be able to explain how all the parts worked. But it is more difficult now. There are more questions; and there are more subjects. The art has advanced. One must have a better knowledge; mere memory will not suffice.

The present edition of the how-to-pass book contains chapters for those desiring to take the radiotelegraph examination, and those aiming at a license to operate radio telephone stations, and much information of interest and value to radio operators generally. The new edition will undoubtedly be as valuable to radio men as the several previous editions.—K.H.

Electrolytic Capacitors

By PAUL MCK. DEELEY. *Cornell-Dubilier Electric Corp., publishers. 1938. 276 pages; illustrated. Price, \$3.00.*

IN OFFERING THE FIRST treatment in English on this subject, the author is able to draw on a large amount of personal experience in the design, manufacture, and use of electrolytic condensers since he holds the position of Chief Engineer, Electrolytic Division, of Cornell-Dubilier. The book deals with such subjects as wet and dry electrolytic condensers, their fabrication, anode film formation, aging, characteristics, testing, and use.

The book is easy to read with little mathematics, and this is simple algebra such as required in the elementary theory of alternating currents. Much practical data is given which is likely to appeal to those engaged in the manufacture of these components. The chapters dealing with the use and application should enable the engineer, amateur, and service man to acquire a more thorough understanding of the characteristics, limitations, and advantages of these condensers, and consequently, to make better use of them in his circuits.—B. D.

TUBES AT WORK

FREQUENCY modulation advances, two new X-ray developments, and a snow-static suppressor for aircraft, are among this month's crop of tube applications

Recent Advances in Frequency Modulation Transmitter Installations

THE DEPARTMENT OF Public Information of Columbia University has recently released information on the 40-kw frequency modulation station now being erected at Alpine, N. J., by Prof. Edwin H. Armstrong of that University. This station, for which a construction permit under the call letters W2XMN has been issued by the FCC, has a 400-ft tower at the top of the 600-ft Palisades, which gives it a commanding position overlooking the entire metropolitan New York area. The tower itself has three 150-ft crossarms. The aerials for the station are supported on vertical booms between the ends of the crossarms. The type of radiator used concentrates the energy to angles near the horizon, and allows but a minimum of energy to be lost in the sky. The station operates on a frequency in the neighborhood of 40 Mc.

The equipment for the transmitter itself has been constructed partially by the Radio Engineering Laboratory, Long Island City, and the remainder by the RCA Manufacturing Company, at Camden, N. J. Arrangements have been made with station WQXR (the high fidelity transmitter operated by J. V. Hogan in New York City) for programs. All studio and recorded programs of WQXR are available for W2XMN on an experimental basis.

Several other stations are in construction at the present time. Two stations are already in operation, the one owned by the General Electric Company, at Albany, N. Y., and the other by the Connecticut State College of Storrs, Conn. Six other stations are reported to be in construction in the East. One is that atop Mount Washington, in New Hampshire, and another on Mount Asnebumskit near Worcester, Mass. According to the Columbia release, receivers have been developed and produced by the General Electric Company at Bridgeport, Conn., which resemble the ordinary broadcast receiver in many respects, and which can be shifted from amplitude modulation to frequency modulation reception by the flip of a switch. It is claimed that these sets, when produced on a quantity basis, will cost no more than an ordinary good radio set of the con-

ventional type. Reception at Bridgeport from The Alpine transmitter was recently successfully demonstrated to a group of leading engineers.

The station at Alpine, N. J., represents an investment of several hundred thousand dollars, and is owned in its entirety by Major Armstrong. During the adjustment of the transmission line, Major Armstrong sat in a boatswain's chair several hours a day adjusting the transmission line, while suspended from one of the cross arms 400 ft. above the ground.

Indicating the interest of present broadcasters in the new method of transmission is the petition now pending before the FCC made by John V. Hogan, owner of WQXR, for a construction permit to build a frequency modulating station in New York City. When and if this application is granted, the station will supply the programs

simultaneously with the conventional amplitude modulated transmissions of WQXR. One of the major differences between the two systems, which has now been demonstrated is the extremely wide dynamic range of the frequency modulated systems, with respect to changes in volume. The compression technique employed in ordinary broadcasting to avoid over-modulation and distortion is not essential in frequency modulation, and as a result the dynamic range of the reproduction is very much greater than is possible in amplitude transmissions.

The editors plan an extensive tour of the several experimental developments in this field, and will report their findings in an early issue.

• • •

Recent Achievements of the Radiometeorograph

AN IMPROVED RADIOMETEORGRAPH, recently constructed by the National Bureau of Standards, has been put into service. The device operates on Olland principle, in which an electric contactor is used to contact successively several measuring instruments. In the new device the contactor is driven by an electric motor weighing only 2 oz. and capable of running for several days from a single flashlight cell of the type used in "pen" flashlights. Rotary contact arms are attached to the pressure, (Continued on page 38)

INVENTORS OF INVISIBLE GLASS

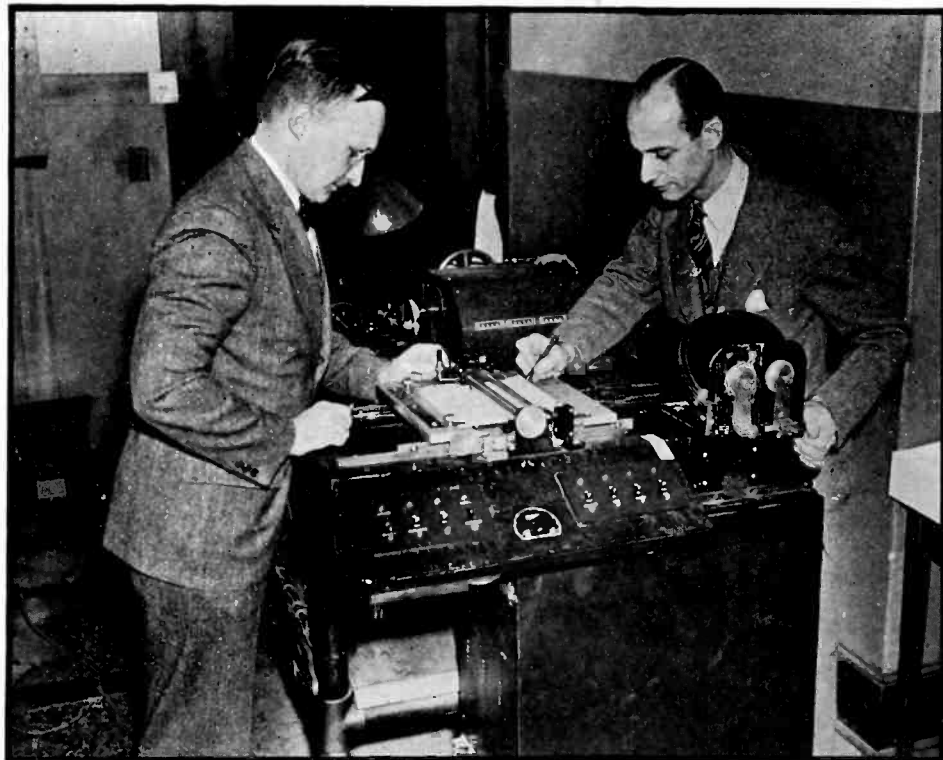

Drs. Arthur F. Turner and C. Hawley Cartwright, physicists at the Massachusetts Institute of Technology, who have jointly developed a method of making "invisible glass" by depositing a thin film of sodium fluoride on the surfaces of clear glass, are shown making measurements of reflection and light transmission on the Hardy spectrophotometer

THREE BASIC ENGINEERING IMPROVEMENTS FOR VOLUME *and* TONE CONTROLS

"METALLIZED" ELEMENT . . .

The ideal surface for noise-free contact is supplied by the famous IRC Metallized type resistance element permanently bonded to a moisture-proof phenolic base.



SPIRAL SPRING . . .

Metal-to-metal sliding contact between end terminal and rotor arm is eliminated by the IRC Silent Spiral Connector. Contact is positive and noise-free.

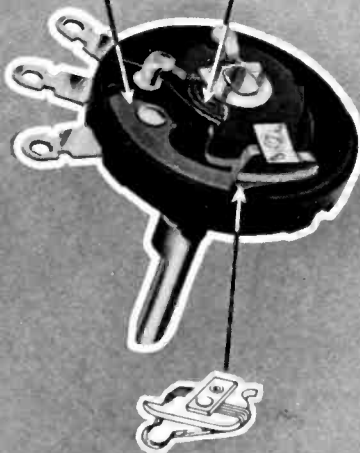

5-FINGER CONTACT . . .

Five separate wire fingers contact the element. Each acts independently; all track smoothly in perfect unison.

Each one
pioneered and
perfected by IRC

All three
available only in



TYPE C S
CONTROLS

INTERNATIONAL RESISTANCE CO., 403 N. BROAD ST., PHILA., PA.

Ferranti

Standard and Special TRANSFORMERS for all Industrial Electronic Equipment

WHAT
FERRANTI
BUILDS
FERRANTI
BUILDS
BEST

A few typical Industrial users of Ferranti transformers —

General Motors Corporation
International Business Machines
Pioneer Instrument Co.
Bell Telephone Laboratories
Sperry Gyroscope
Texas Company
RCA Manufacturing Co.
Hamilton Standard Propellers
Western Electric Co.
General Electric Co.
Associated Press
Eastman Kodak Co.
International Projector Corp.
Fairchild Aerial Camera Corp.

Ferranti

FOR
VALUE
RECEIVED

ELECTRIC
INCORPORATED
RCA BUILDING
NEW YORK, N. Y.

temperature and humidity elements. The contact keys a small radio transmitter, and the timing of the contact indicates the position of the measuring element. The accuracy achieved in the new device is exceptional; pressure measurement is reliable to 2/10 per cent, the temperature measuring to 1 per cent and the humidity measuring to approximately 5 per cent. Tests of the equipment to altitudes as high as 12 miles have proved entirely satisfactory.

• • •

U. S. Steel Reports Savings from Photoelectric Furnace Control

SAVINGS OF AS high as 50 per cent in the life of refractory brick lining in open-hearth furnaces were reported recently by Dr. John Johnston, Director of Research of the United States Steel Corporation. Dr. Johnston points out that the "customer's requirements" for modern steel, particularly relating to

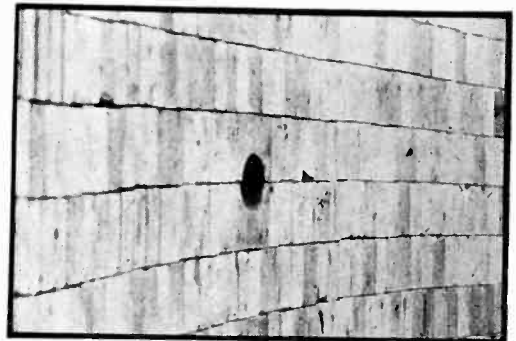

Fig. 1—Interior view of fire brick of furnace, showing aperture through which heat is observed by phototube

grain size and tensile strength, make accurate temperature control necessary throughout the production of the metal, and in particular in the open-hearth process. The photoelectric control unit now used consists of a phototube which views the interior of the furnace through windows in the sides. The tube views the top of the furnace, rather than the heated metal itself. If the inside temperature goes above specified limits, the brightness of the roof of the furnace changes sufficiently to actuate

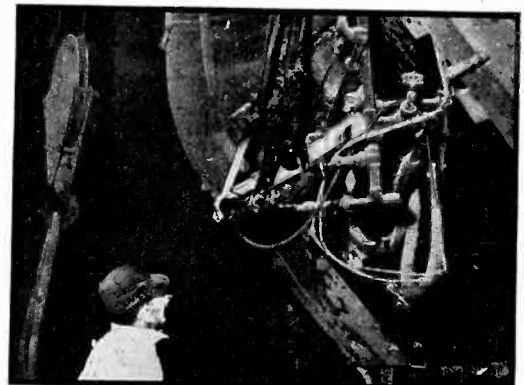
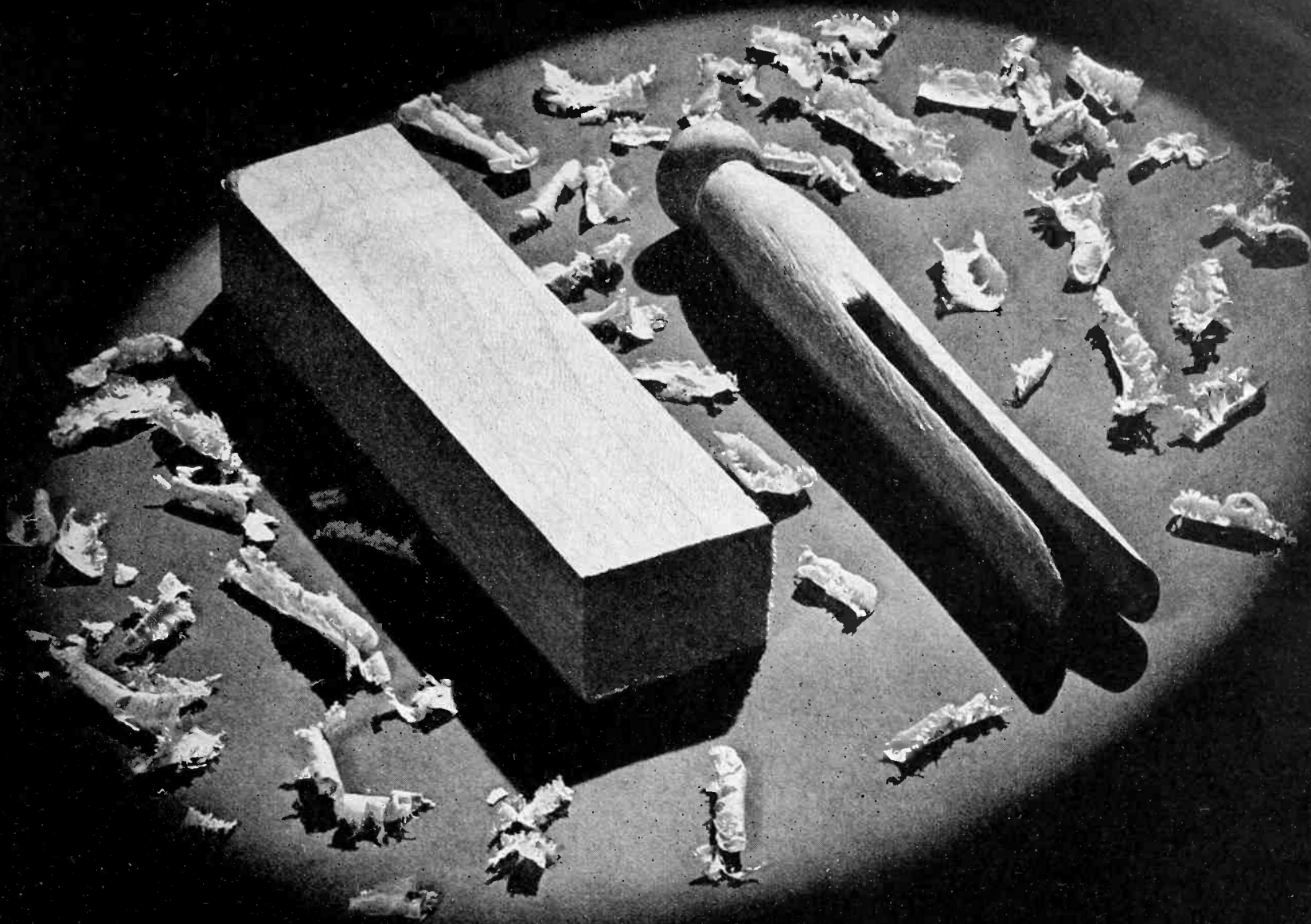
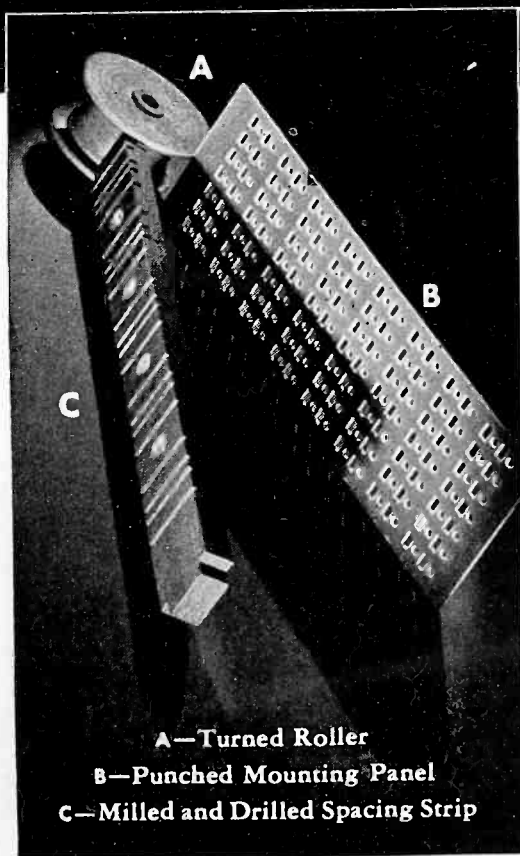

Fig. 2—Installation of phototube temperature control in furnace at the Gary Works of the Carnegie-Illinois Steel Corporation



What! Buy wood to whittle clothespins?



A—Turned Roller
B—Punched Mounting Panel
C—Milled and Drilled Spacing Strip

THEN WHAT ABOUT PARTS FOR YOUR OWN PRODUCT?

If your wife needed clothespins you wouldn't buy the wood and make them yourself. A homely example but . . . you may be making parts for your product that you should buy . . . where conversion by you isn't worth its inconvenience and cost. Possibly we can help you as we've helped others.

First, by the use of Synthane Bakelite-laminated . . . a versatile material with a combination of many desirable properties. Second, by doing the entire job of machining.

When you turn the whole job over to us you relieve yourself of the responsibility for jigs and fixtures, for tooling up, for mistakes and rejects, for deliveries. You eliminate capital expense for productive equip-

ment, interest charges and charge-offs for depreciation. You take advantage of the economies which come from our special equipment, specialized experience and methods.

What you pay for is always a *known* quantity in your costs. In short, you get what you want, when you want it, at a definite price, without any production worries and most important . . . usually at an attractive saving in conversion costs.

As an example, it paid three widely different manufacturers to have us produce the products at the left. If you are interested in this convenience and economy write us your requirements. You have nothing to lose.

If you are already set-up to machine parts economically we can supply you with Synthane Sheets, Rods, and Tubes . . . help you in every way we can.

SHEETS • RODS • TUBES • FABRICATED PARTS • SILENT STABILIZED GEAR MATERIAL

SYNTHANE CORPORATION, OAKS, PENNSYLVANIA

SYNTHANE
Bakelite —  Laminated

NOT THE LARGEST..



but..

EVERYTHING YOU HAVE A RIGHT TO EXPECT IN RELAYS *by* GUARDIAN



ENGINEERING LABORATORY
Devoted solely to the design of electrical control units from simple to most intricate combinations . . . uniform in size . . . space-saving . . . better and more economical.

Above—One of Guardian's highly specialized relay departments, where small . . . compact Relays by Guardian are built to give maximum control in minimum space.

Such efficiency and economy is partly achieved by Guardian's unique relay construction.

Improve your product . . . eliminate excessive mechanisms . . . make it more responsive . . . more efficient . . . less costly . . . more saleable with Midget Relays by Guardian.

Guardian equipment offers everything you have a right to expect in uniform, faultless, dependable controls.

ASK US TO MAKE SPECIFIC RECOMMENDATIONS TO FIT YOUR SPECIAL NEEDS. WRITE FOR CATALOG E TODAY.

When ordering specify current, voltage or resistance of coil, contact combination and load on contacts.

For Quick Reference to Relays by Guardian, See Thomas' Register

GUARDIAN  ELECTRIC
1625 W. WALNUT STREET CHICAGO, ILLINOIS

the phototube which regulates the supply of fuel accordingly. The improved quality of steel is not the only result of this automatic control. Longer life in the refractory-brick lining has also resulted. In non-regulated furnaces it is necessary to shut down the furnace for repair to the brick after processing approximately 300 batches of steel. When the automatic temperature control is put in operation, 450 to 500 batches of steel may be produced before repairs are necessary. The temperature control also allows a higher average temperature while the furnace is in operation and thus reduces the time required to process the steel. While the saving in time is a matter of minutes only, the saving is measured in thousands of dollars per furnace each year.

. . .

An Oscilloscope as a "Wow" Detector

BY EARL TRAVIS, KVEC

THE PRESENCE OF a "wow" (defined as periodic speed variation in a phonograph turntable) often brings forth heated debate which usually ends up with personal remarks about the hearing ability of different engineers.

A simple check which can be used to advantage not only in broadcast stations, but by turntable manufacturers, service men, and others who work with recorded sound, is to use an oscilloscope. A stable audio oscillator is also necessary. The output of the oscillator is put on the vertical plates of the oscilloscope

JOLIOT-CURIE CYCLOTRON



As an aid in fighting cancer, the Joliot-Curie cyclotron has recently been completed at the New College of France, for the production of artificial radium. Natural radium was discovered in 1896 by Pierre and Marie Curie whose son-in-law and daughter are carrying on their scientific investigations.

You Can Tell at a Glance

WHY ERIE INSULATED RESISTORS CAN *Increase* THE *Efficiency* OF YOUR EQUIPMENT

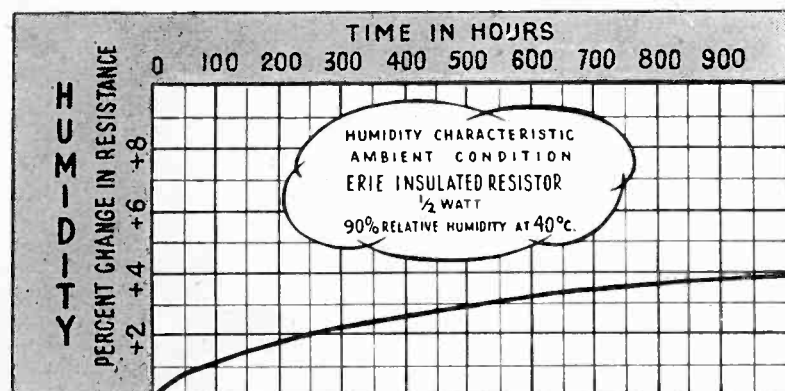
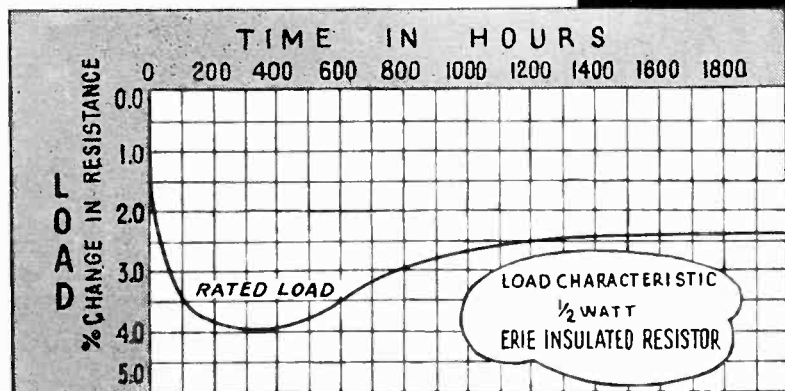
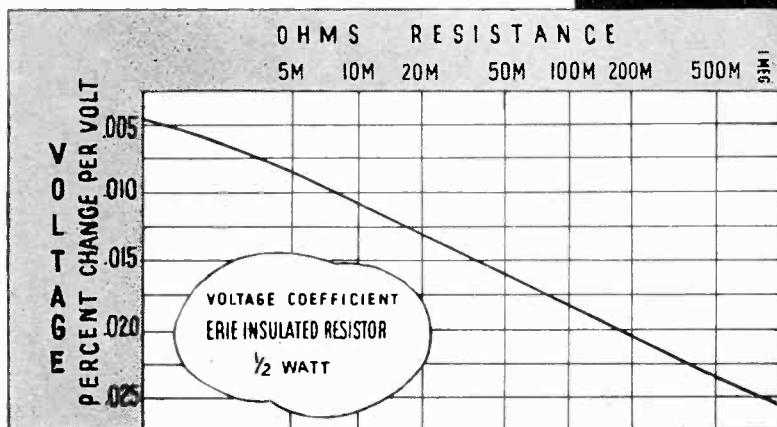

Right: Type YI Erie 1/2-Watt Insulated Resistor shown actual size. Same style resistor also made with 1 watt rating.

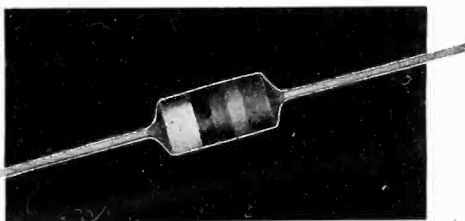

If you are having trouble with insulated resistors in plate circuits where widely fluctuating voltages cause excessive changes in resistance values, a sure cure lies in the extremely low voltage coefficient of Erie Insulated Resistors, as shown in the top chart.

Do you require a resistor that must have good load characteristics? Take a look at the middle chart and see how 1/2 Watt Erie Insulated Resistors "can take it." They change less than 2.50% in resistance value when operated at rated load for 2,000 hours!

Does the effect of humidity lower the operating efficiency of your equipment? The bottom chart shows how you can eliminate this trouble by using Erie insulated resistors.

The fact that in ONE resistor these changes in electrical characteristics are uniformly small, makes it the ideal unit for use under all varying types of conditions.

We will be glad to send you a generous supply of samples to put through your own particular tests. Write today.

ERIE RESISTOR CORPORATION, Erie, Pa.

TORONTO, CANADA • LONDON, ENGLAND • PARIS, FRANCE - J.E. CANETTI CO.

MANUFACTURERS OF RESISTORS • CONDENSERS • MOLDED PLASTICS

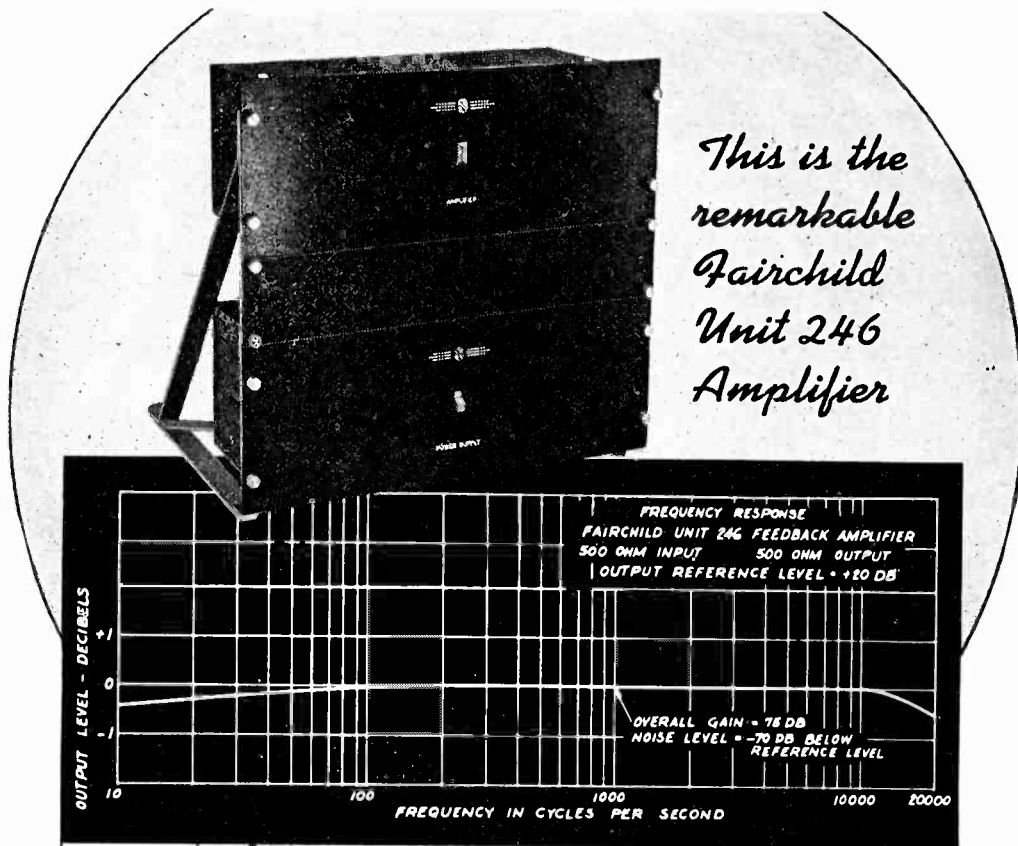

This is the remarkable Fairchild Unit 246 Amplifier

IMAGINE A FEED-BACK AMPLIFIER FLAT WITHIN .3 OF A DECIBEL FROM 15 TO 15,000 CYCLES . . . !

From Fairchild's precision-instrument laboratories has come a feed-back amplifier which sets a new standard for distortion-free range. Designed to meet the demand for greater fidelity in broadcasting, recording, playbacks and in the laboratory, it has literally amazed engineers who gave it thorough tests at recent previews. The specifications speak for themselves:

- | | |
|--|---|
| Overall gain—75 db. | Distortion: .3% at rated output. |
| Noise level—50 db below "0" level. | Size: Fits 19 1/2" relay rack—7" high |
| Rated at 23 watts into 500 ohm resistive load. | panel. 2 units—amplifier and power supply each this size. |
| Input impedance Multiple line: 50, 125, 250, 500 ohms. | Cover: Dust cover removable from rear—quick release, no screws. |
| Output impedance: 16 and 500 ohms. | Accessibility: Front panel removable by release of four thumb screws. All wiring then accessible. |
| Input line volts: 110 to 125V; 50 to 60 cycles AC. | |

For full information, send for descriptive literature

"... it had to satisfy Fairchild first"



FAIRCHILD
 Sound Equipment Division
FAIRCHILD
 AERIAL CAMERA CORPORATION
 88-06 Van Wyck Boulevard, Jamaica, L. I., N. Y.

and the phono pickup is connected to the horizontal plates. A standard frequency record is put on the turntable and reproduced through the pickup. When the audio oscillator is adjusted to the same frequency as the record, the oscilloscope pattern is an oval. If the oval remains fixed in shape all is well, but if there is the least speed variation in the turntable, the oval will disappear at regular intervals.

It is usually possible to mark the turntable with respect to some stationary object just when the oval starts to change shape, and then to turn the table by hand to where the marks line up. Further examination will show what parts of the worm, gear teeth or other parts of the driving mechanism are together at this particular instant, and may lead directly to the cause of the speed irregularity.



Aircraft Static Suppressor Installed on United Air Lines Ships

A FORM OF STATIC particularly severe in aircraft is known as "precipitation static", which results from the discharge of electricity accumulated on the plane as it travels through regions of different potential. The discharge, it was found in a series of tests conducted by United Air Lines engineers, occurs at the after edges of the plane



Static suppressor device, which when released from the tail of an airplane prevents static discharges from the plane surfaces

where the surfaces of the plane make the sharpest angles. The electrical noise produced by this discharge was so great that in many cases it completely crippled the radio communication system in the plane. Various anti-static devices, such as loop antennas, completely shielded electrostatically, have been employed but have provided

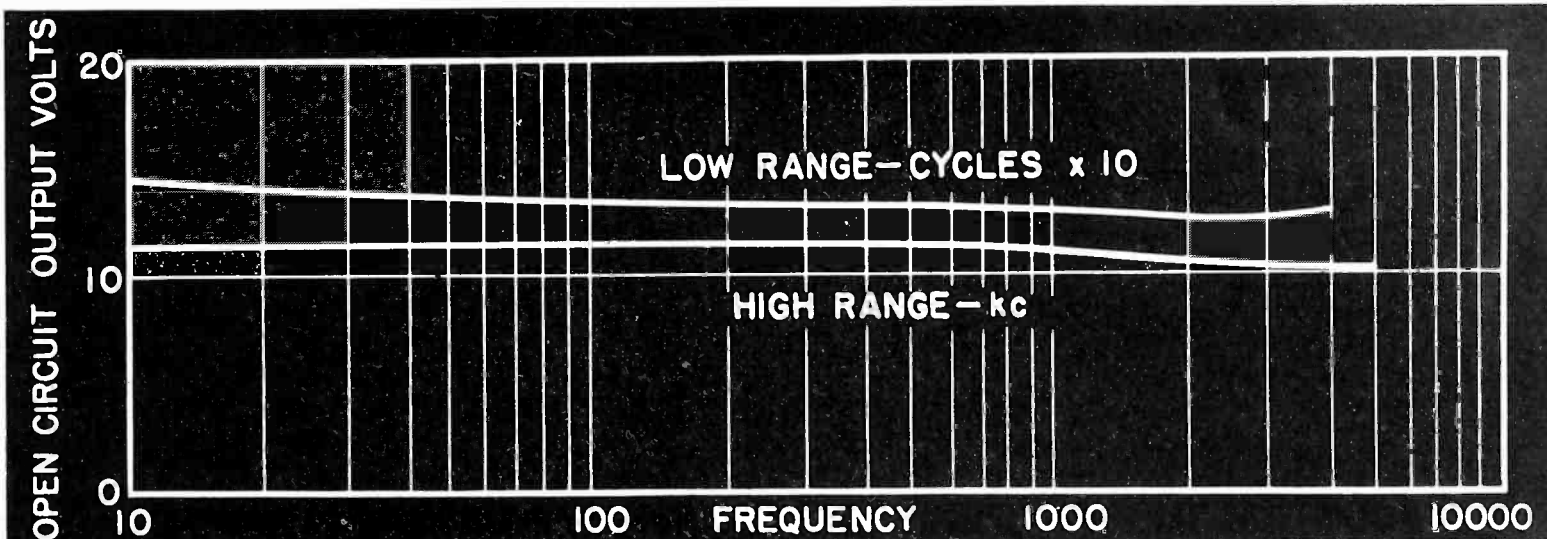

New Wide-Range Beat-Frequency Oscillator

FEATURES

FOR some time there has been need for a wide-range oscillator with substantially constant output of moderate power, not only for general laboratory bridge measurements but also for taking selectivity curves over a very wide range of frequencies, for measuring transmission characteristics of filters and for testing wide-band systems such as television amplifiers and coaxial cables.

The new General Radio Type 700-A Beat-Frequency Oscillator was designed for these applications. Through unique circuit and mechanical design and very careful mechanical construction it has been possible to manufacture an oscillator of good stability, output and waveform at an exceptionally low price.

WIDE RANGE—two ranges: 50 cycles to 40 kc and 10 kc to 5 Mc.

DIRECT READING—scale on main dial approximately logarithmic in frequency. Incremental frequency dial direct reading between -100 and $+100$ cycles on low range and -10 and $+10$ kilocycles on high range.

ACCURATE CALIBRATION—low range: $\pm 2\% \pm 5$ cycles; high range: $\pm 2\% \pm 1000$ cycles; incremental dial: ± 5 cycles low range; ± 500 cycles high range.

GOOD FREQUENCY STABILITY—adequate thermal distribution and ventilation assure minimum frequency drift. Oscillator can be reset to zero beat to eliminate errors caused by small drifts.

GROUNDING OUTPUT TERMINAL—output taken from 1,500 ohm potentiometer.

CONSTANT OUTPUT VOLTAGE—open-circuit voltage remains constant between 10 and 15 volts within ± 1.5 db over entire frequency range.

WAVEFORM—total harmonic content of open-circuit voltage is less than 3% above 250 cycles on low range and above 25 kc on high range.

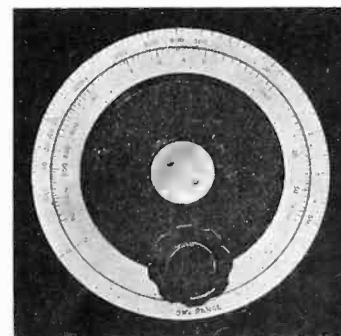

Type 700-A Wide-Range Beat-Frequency Oscillator .. **\$555.00**

• Write For Bulletin 364 For Complete Information

GENERAL RADIO COMPANY, Cambridge, Mass. NEW YORK LOS ANGELES

MANUFACTURERS OF PRECISION RADIO LABORATORY APPARATUS

RELAYS

by **AUTOMATIC ELECTRIC**

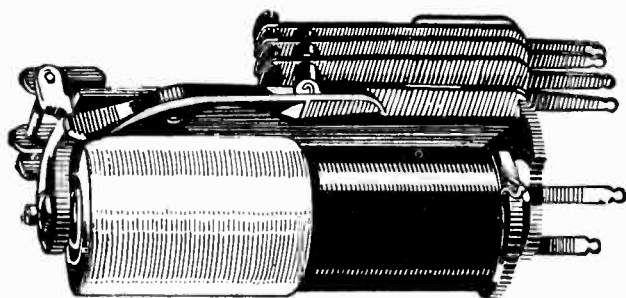

When you buy an Automatic Electric Relay you get a precision product designed and constructed by an experienced company—for Automatic Electric has been making relays for over forty years!

For EVERY Industrial Need!

The Automatic Electric line of relays includes quick and delayed action types, sensitive and heavy duty types, mechanical locking types, polarized relays, etc. Available with any contact combination and for operation on D.C. or A.C. circuits of any voltage.

Write for complete illustrated catalog of relays, stepping switches, electric counters, solenoids, keys, and other electrical control accessories. Address American Automatic Electric Sales Company, 1033 W. Van Buren St., Chicago.

AUTOMATIC  **ELECTRIC**

MAKERS OF TELEPHONE AND SIGNALING APPARATUS
ELECTRICAL ENGINEERS, DESIGNERS AND CONSULTANTS

only partial relief from the trouble. This type of static is especially serious since it occurs when radio communication is most important, during snow, heavy rains, and in clouds.

A new device in the form of a wire which trails from the tail of the plane has been perfected by the United Air Lines working with the Bendix Radio Corporation. In the tail of the ship, as shown in the accompanying picture, two pockets are constructed, each containing a rocket-like contrivance, which is released from the tail of the plane by an electrical release device actuated by the pilot. Actually the rocket consists simply of a wind sock and a spring release for curling out a length of approximately 50 or 60 ft. of fine steel wire. This wire is of small enough diameter to constitute the sharpest radius of curvature on the surface of the plane. In consequence the static discharge occurs from the wire rather than from the other parts of the fuselage. The wire is long enough so that the discharge occurs at a considerable distance behind the plane itself, and is thus removed from the vicinity of the receiving antennas of the radio system. To prevent re-entrance of radio frequency components from the discharge wire, a suppressor is included in the length of the wire in the form of resistor especially designed for use in the trailing wire. This resistor acts in the same way as the suppressor resistor in an automobile radio installation. Two complete units are carried to provide a spare in the event that two "attacks" of static are met in a single flight. The device is being installed on all the Douglas twin-engined transports of the United Air Lines, and is available for other planes as well.

• • •

KGLO's Mobile Unit Travels 3,500 Miles in Five Months

AN UNUSUAL EXAMPLE of active coverage of special events by mobile unit has been achieved by the staff of KGLO, Mason City, Iowa. In five months the unit has traveled some 3,500 miles, all within a radius of 100 miles from the base station, covering fairs, celebrations and other special events. Two relay frequencies are used, 2790 kilo-



3500 miles in five months is the record of KGLO'S mobile unit

CRYSTAL TRIUMPHS 1/2" INCH LOCTAL SOCKETS

THE ORIGINAL, COMPLETE AND SATISFACTORY SOCKET FOR THE NEW LOCTAL TUBE

With the introduction of the new Loctal Tube — comes the new Cinch socket; already in extensive use, it has proved most efficient. *Cinch pioneers again!*

Flexible in applying its services, a scientifically trained organization anticipates changing conditions. Satisfied customers everywhere commend the proven "Cinch" policy — "Your problems are our problems."

Sockets Actual Size→

CINCH

MANUFACTURING CORPORATION
2335 WEST VAN BUREN STREET, CHICAGO, ILL.

Subsidiary: United-Carr Fastener Corp., Cambridge, Mass.

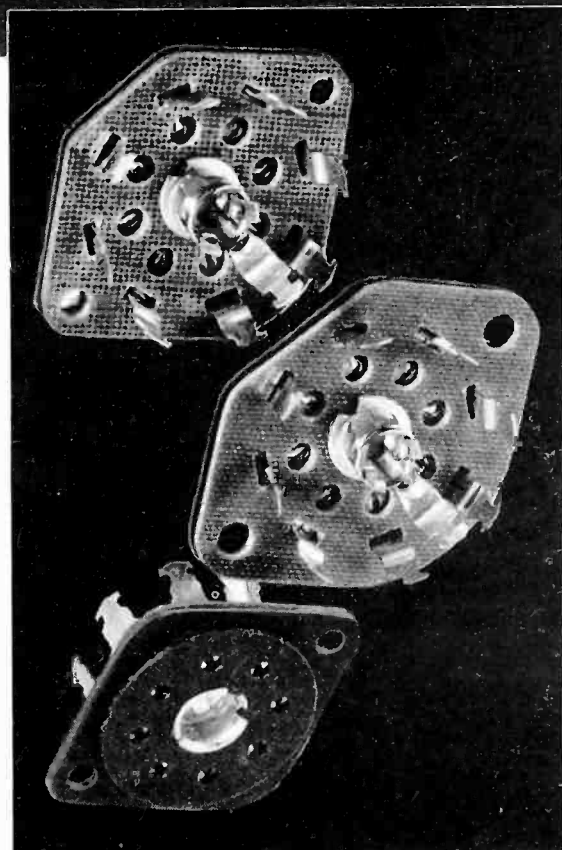

6778
1 1/2" M.C.

6758
1 1/16" M.C.

6738
1 5/16" M.C.

CERAMIC TUBE BASES

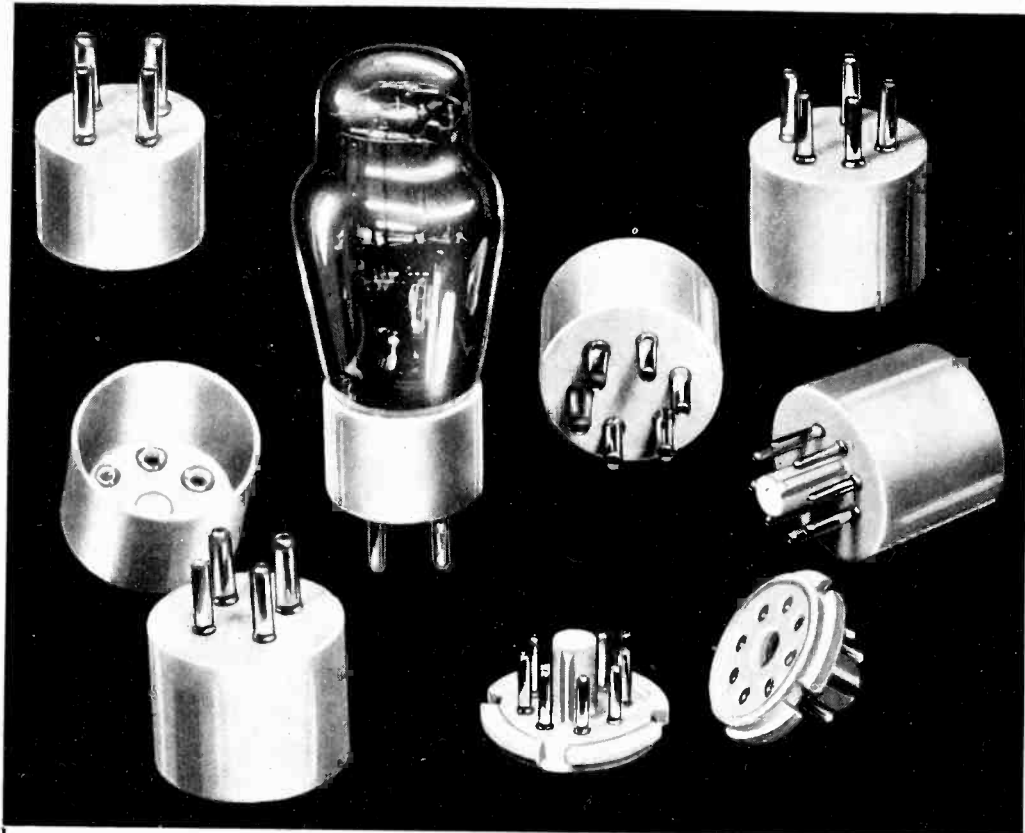

Bases made from low-loss, glazed Alsimag are now available for the usual applications at no extra cost. Television assemblies are also improved by using these same bases.

Quick deliveries can be made as all sizes and combinations are carried in stock. Upon request, literature and prices on given quantities can be supplied.

AMERICAN *Lava Corporation*
CHATTANOOGA, TENN.

Sales Offices

NEW YORK
BOSTON
PHILADELPHIA

WASHINGTON
CLEVELAND
CHICAGO

ST. LOUIS
LOS ANGELES
SAN FRANCISCO

cycles relaying from the truck to the main transmitter, and 31,100 kilocycles for local pick-up work used with a portable transmitter which relays the report to the truck whence it is transmitted on 2790 kc. to the main transmitter. The ultra high frequency unit is used for pick-ups which must occur more than 500 ft. from the truck. Microphone cables up to 500 ft. are available for closer work. The antenna used for relay work depends on the distance to be covered. A 10-ft. vertical pole suffices for distances up to 15 miles. When the antenna is telescoped out to its full length of 30 ft., a range of 50 miles can be obtained, whereas for distances up to 100 miles a short vertical antenna, either one-quarter wave or a half wave long is used and makes possible reproduction of good broadcast quality up to 300 miles. Power supply for the truck may be obtained directly from local distribution circuits when they are available or from a 110-volt a-c motor-driven Kato generator, which has sufficient power to operate the entire station as well as the beacon lights on the antenna.

• • •

CBS Develops Portable Audio Measuring Set

THE ENGINEERING department of the Columbia Broadcasting System has recently developed a complete automatic audio measuring equipment which has been set up in one of the studios of

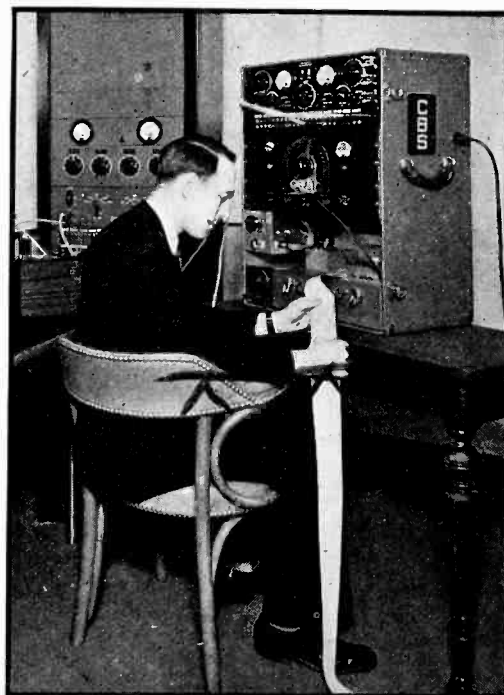

CBS automatic audio measuring set

station WABC. The equipment is portable and a-c operated, and is intended for measuring the response-frequency characteristics of a complete system or of any individual component part, such as an amplifier, filter, line, etc. For such measurements the equipment auto-

RELAYS THAT "Click" IN MODERN CONTROL CIRCUITS

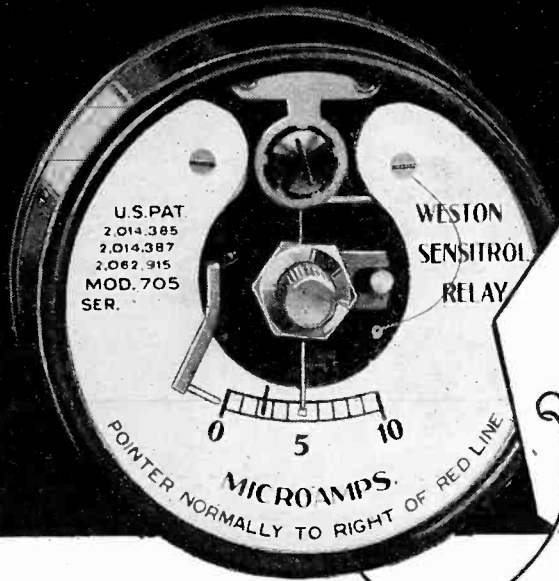

WESTON Model 705 Sensitrol Relays

Operate from thermocouples, resistance thermometers, photocells and electronic circuits . . . provide positive control at energy levels as low as 1 millivolt or 2 microamperes . . . handle 50 milliamperes at 110 volts on contacts . . . made in hand reset and solenoid reset types.

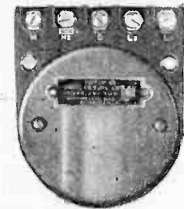

Time Delay Relays (Model 613)

Compensated bi-metal operation . . . single or double circuit . . . provides time delay of 15 sec. to 1 minute between initial impulse and operation . . . handles up to 25 watts at 110-volts output.



Sensitive Relays (Model 30)

Permanent magnet, movable coil operation . . . for circuits up to 200 milliamperes, 6 volts, DC . . . in types for "high-low" voltage (or current) control, and for regulation of voltage (or current) within 1%. Also "microampere" type, operating from high-side to low-side at a minimum differential of 15 microamperes.



Sensitive Indicating Relays (Model 730)

Designed specifically for alarm circuit use where current is normally held at 2 milliamperes . . . standard model serves as indicator over 0-4 milliamperere range, with contacts at 1 and 3 milliamperes . . . compact and inexpensive.

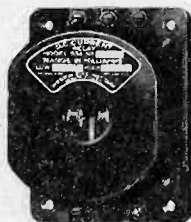

Sensitive Relays (Model 534)

Compact, permanent magnet, movable coil operation . . . for circuits up to 200 milliamperes, 6 volts, DC . . . for surface or flush mounting in current relay, voltage relay or "microampere" types.



Power Relays (Model 630)

Electro-magnetic type with one to four mercury switch contacts . . . designed particularly for use with sensitive relays to supply output energy up to 1000 watts . . . operate on 6 volts DC, or from transformer rectifier unit.

No matter how limited the energy available—down to a bare 2 microamperes—WESTON Sensitrol Relays, with indicating scales, can put it to work as a means of positive control. Similarly, if operating speed, high output or some other critical element is the limiting factor, there are other WESTON Relays which meet each requirement "on the nose."

Today, as engineers and industrial executives make plans for safer, surer and more flexible means of electrified control, they design their circuits around the positive, unfailing contacts of WESTON Relays. One or more of these units is almost certain to meet your own specific needs. Why not write for a copy of "WESTON Relays"—a 12-page bulletin giving full specifications? Weston Electrical Instrument Corp., 618 Frelinghuysen Ave., Newark, N. J.

WESTON Instruments



STREAMLINE YOUR
PRODUCTION
WITH



Punched Insulating Parts

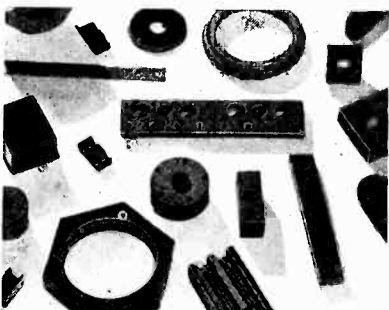

Machined Insulating Parts

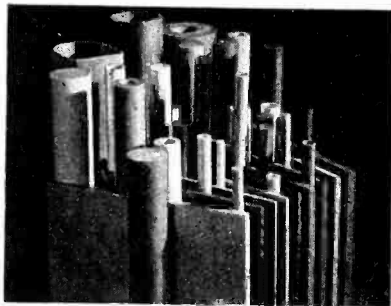

Sheets—Rods—Tubes

DILECTO

*a Laminated Plastic made
to meet your specific*

INSULATING PROBLEM

There is never a let-up at Continental-Diamond's Research Laboratory in its study of individual insulating problems and the development of materials to meet them. If you have not availed yourself of the technical service which we offer you are probably overlooking an opportunity to facilitate production, improve performance or cut costs.

The adaptability of DILECTO is almost limitless; and the ability of our Laboratory to predetermine properties is accurate to a high degree. Thus, a study of your problem may uncover some slight or important change that would provide the solution helping to speed up production, improve product performance or lower costs. Write and let us show you what we can do.

CONTINENTAL-DIAMOND FIBRE COMPANY

NEWARK, DELAWARE

Represented in Canada by
Diamond State Fibre Co., of Canada, Limited
Toronto Montreal

matically traces a curve of the amplitude response versus frequency of the equipment under test. The device may also be used for reverberation studies and for general acoustic measurements. When used for recording the growth or decay of sound, the maximum rate which the machine will accommodate is 560 db. per second. The equipment was developed by H. A. Chinn and V. N. James of the General Engineering Department of CBS.

• • •

New Million-Volt X-Ray Employs Resonance Transformer and Gas Insulation

FOLLOWING A LONG study by General Electric Engineers to produce a high voltage X-ray equipment of compact dimensions and low cost, that company

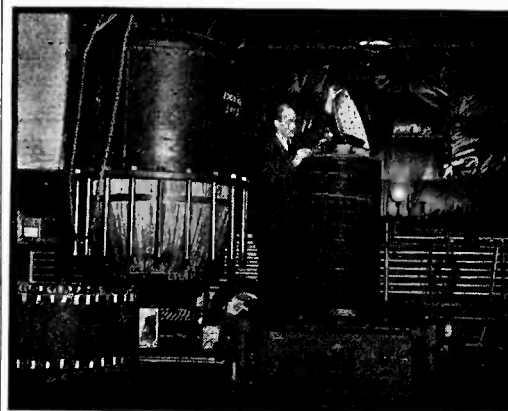

Extremely compact million volt x-ray generating equipment has been developed by the General Electric Co. Instead of using an iron core as in usual transformer construction, the transformer is operated at its resonant frequency and has an air core

has announced the development of a complete X-ray equipment to be installed this spring at the Memorial Hospital, New York City for research in the treatment of cancer. The X-ray tube employed operates at a million volts, peak, with a current of 3 milli-



The filament end of the X-ray tube, and a part of the automatic control mechanism. The shield serves to protect this part of the tube from discharges, since this is the high potential end of the device

Even Your Conservative Models Gain New Personality from Bakelite Molded



(Above) Conservative, yet striking, is this "Fadalette" housed in walnut-colored Bakelite Molded. Complete cabinet, including louvre-like grill, formed in one piece. Stokes Rubber Co., molder.

(Right) Distinctive styling for this Clinton table radio is obtained with a one-piece cabinet of lustrous black Bakelite Molded. Auburn Button Works, molder.



TO GAIN DISTINCTIVE STYLING in conservative cabinets... that is often one of the most difficult styling tasks. Yet, see how well it has been achieved in the cabinets shown—through use of Bakelite Molded!

In the Clinton Set, continuous grooves around top and sides, and tiny connecting links between grillwork bars, combine to create personality in a simple basic design. In the Fada cabinet, unusual louvre-like grooves containing grill openings furnish an original effect. Each model is completely produced in one piece from Bakelite Molded.

For any new departures in cabinet styling, involving unusual forms, Bakelite Molded permits even greater freedom of design. Available in all colors from white or pastel shades to midnight black... in transparent, translucent or opaque effects... it also provides rich color without separate finishing operations.

Learn how Bakelite Molded and other Bakelite plastics can help you to design bigger-selling cabinets,

and improve electrical performance of sets. Write for Portfolio 13 of illustrated booklets describing many of these materials.

BAKELITE CORPORATION, 247 Park Ave., New York

Chicago: 43 East Ohio Street

BAKELITE CORPORATION OF CANADA, LTD., 163 Dufferin St., Toronto
West Coast: Electrical Specialty Co., Inc., San Francisco, Los Angeles and Seattle

Consult Bakelite Headquarters for Plastics

At this single central source, more than 2,000 plastic materials are available, including molding materials, laminated stock and insulating varnishes of unusual value to radio designers. They offer wide selection of color, transparent or opaque effects, toughness, power factor and other characteristics.

Fill your needs more accurately with Bakelite POLYSTYRENES, UREAS, CELLULOSE-ACETATES, PHENOLICS.

BAKELITE

The registered trade mark shown above designates materials manufactured by Bakelite Corporation. Under the name "B" in the trademark logo to signify, or unaltered quality, it indicates the infinite number of plastic and resin uses of Bakelite Corporation's products.

PLASTICS HEADQUARTERS

VISIT THE BAKELITE EXHIBIT, HALL OF INDUSTRIAL SCIENCE, NEW YORK WORLD'S FAIR 1939

INSUROK

THE SUPERIOR PLASTIC

MOLDED PARTS AND PRODUCTS

for

ELECTRICAL INSULATION

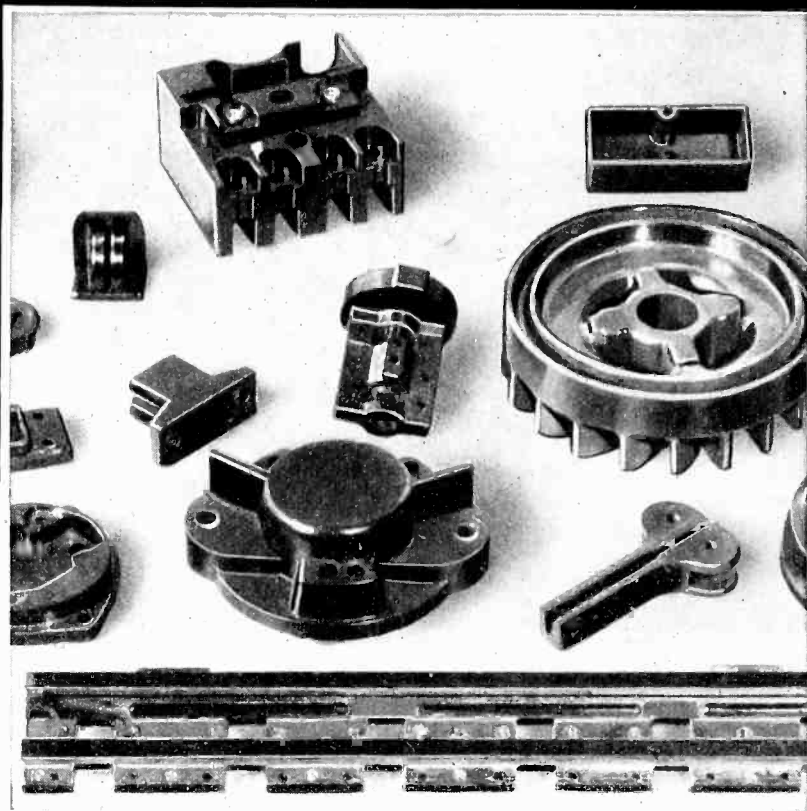

● To select Richardson as your source of supply, and INSUROK for your molded plastic parts and products, is to solve a major production problem. Whatever your plastic requirements, it will be to your profitable advantage to see Richardson first.

Richardson Research, Design and Engineering staff will be glad to discuss any problem involving the use of plastics. Literature on request.

The RICHARDSON COMPANY

Melrose Park, (Chicago) Ill. Founded 1858 Lockland, (Cincinnati) Ohio
 New Brunswick, N. J. Indianapolis, Ind.
 Detroit Office: 4-252 G. M. Building, Phone Madison 9386
 New York Office: 75 West Street, Phone Whitehall 4-4487

amperes. The outfit operates on 3 phase, 60 cycle power, and employs a specially designed transformer which contains no iron core. Rather, the principle of the tuned transformer is employed. The high tension winding of the transformer consists of more than 100 coils of wire, each being in the form of a thin flat pancake with a hole in the center. The primary coil is a pancake coil of stiff copper, which is mounted at the base of the equipment. The secondary coils are stacked above, thus forming a cylindrical structure through the center of which the X-ray tube itself passes. The tube thus occupies the position normally taken by the



L. E. Dempster and W. F. Westendrop, assembling a million volt x-ray equipment. A novel feature of the construction is that the tube is enclosed in the center of the transformer, and that the equipment is small enough for installation in existing hospitals.

core of the transformer. Insulation of the transformer is obtained by enclosing it in a gas-tight tank and filling the tank with dichlorodifluoromethane, a colorless non-poisonous gas of extremely stable characteristics. The gas weighs 100 lb., and takes the place of 12,000 lb. of conventional insulating transformer oil which has been used in similar installations. By virtue of this insulating system, and the unusual arrangement of the transformer and tubes, the entire device is extremely compact and may be installed in existing hospital buildings. The comparable installation of 1933 for 800,000 volts required a building 52 ft. long, 32 ft. wide and 36 ft. high. The new equipment in contrast is about 8 ft. tall and approximately 6 ft. in diameter (these being the dimensions of the gas-tight tank.)

The tube itself is built in eleven sections, each section containing a corona shield which distributes the potential

Mercury Vapor Rectifiers

THAT GIVE YOU LONG LIFE AND FREEDOM FROM INTERRUPTIONS

Broadcasting stations all over the country have found these six tubes remarkable for their long life, reliability and freedom from arcbreak.

Important features are:

1. *Enclosed field structure:* the anode surrounds the

cathode shield and limits ionization to a small volume.

2. *Rugged filament design.*

3. *Reliable glass construction:* careful control of manufacturing processes minimizes glass strains.

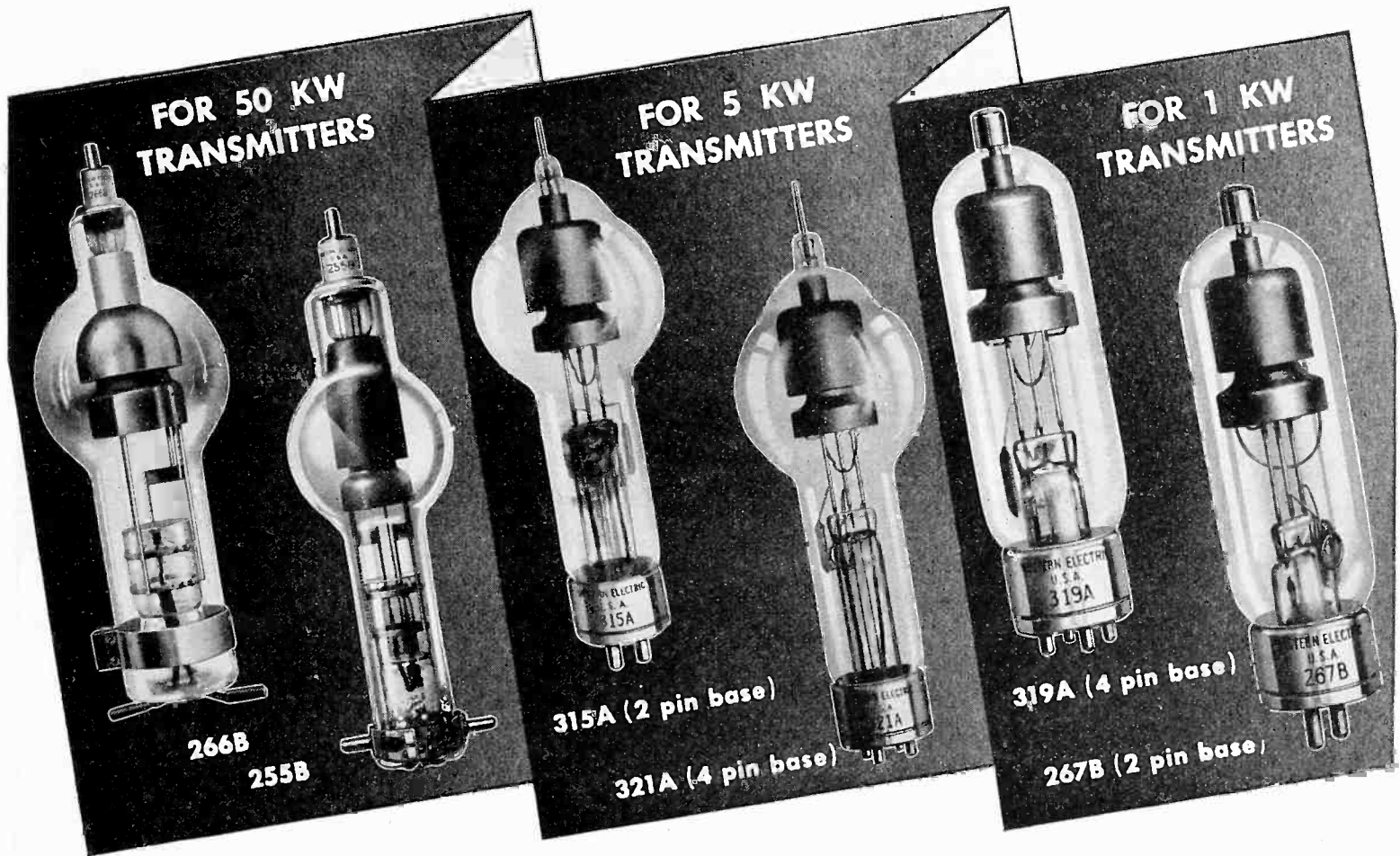

CHARACTERISTICS

	266B	255B	315A-321A	267B-319A
Filament voltage	5 volts	5 volts	5 volts	5 volts
Filament current	42 amperes	19 amperes	10 amperes	6.75 amperes
Maximum peak plate current	20 amperes	10 amperes	2.5 amperes	2.5 amperes
Maximum peak inverse potential	20,000 volts	20,000 volts	12,500 volts	7,500 volts

DISTRIBUTORS

Graybar Electric Company, Graybar Building, New York City. In Canada: Northern Electric Co., Ltd. In other foreign countries: International Standard Electric Corp.

Western Electric
ELECTRONIC EQUIPMENT



Globar
REG. U. S. PAT. OFF.

CAN SUPPLY

**MANY
SHAPES,
SIZES AND
TYPES OF
CERAMIC
RESISTORS**

*Write us concerning
your difficult
resistance problems*

THEY ARE OUR SPECIALTY

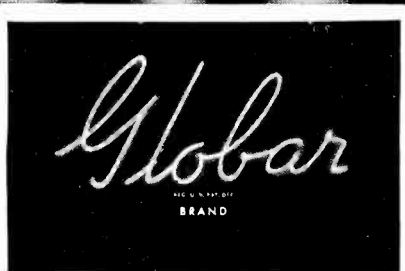
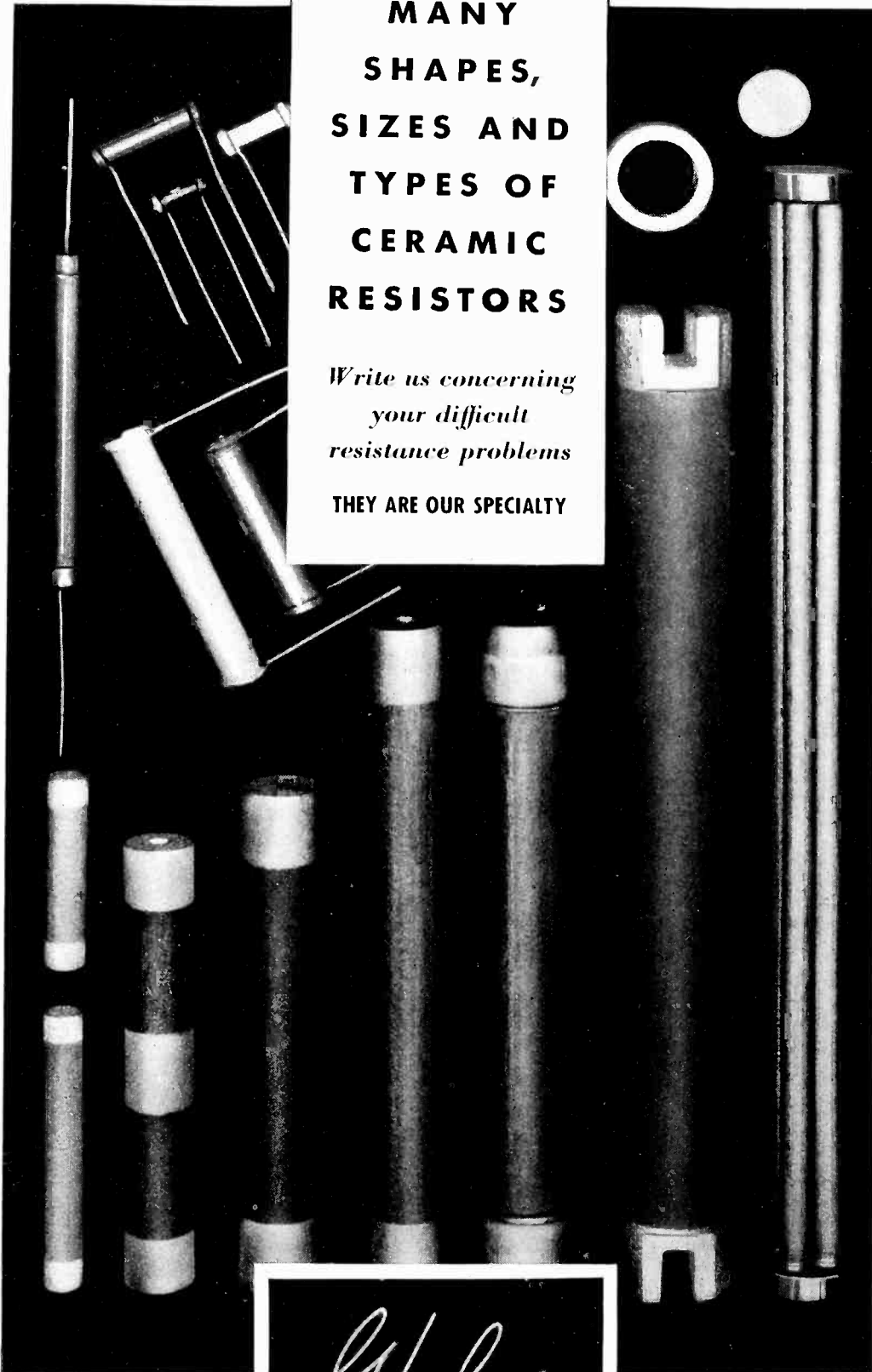

**GLOBAL DIVISION
THE CARBORUNDUM COMPANY • NIAGARA FALLS, N. Y.**

REG. U. S. PAT. OFF.
Sales Offices and Warehouses in New York, Chicago, Philadelphia, Detroit, Cleveland, Boston,
Pittsburgh, Cincinnati, Grand Rapids
(Carborundum and Globar are registered trade-marks of The Carborundum Company)

equally along the length of the tube. The entire tube is 56 in. long and 3½ in. in diameter. The tube itself extends below the bottom of the gas enclosure for a distance of about 23 in., and it is from this portion of the tube that the X-ray radiation is obtained. The entire equipment weighs about 2 tons including 1,000 lb. of protecting lead shielding. All adjustments of the voltage applied to the tube and the current through it are made remotely through electrically controlled circuits.

• • •

Discharge Tube for Relay Contacts

THE EDITORS ARE indebted to Mr. Frederic S. Beale, of M.I.T. for the suggestion that a neon discharge tube may be used to shunt an inductive load in relay operation. Mr. Beale notes the suggestion of Mr. A. W. Clement in "Troubles with Relay Contacts," which appeared in the December issue, that inductive loads be shunted with non-inductive resistance. If a discharge tube is used, the loading effect of the resistance is avoided, and the speed of operation is very high. The only requirement is that sufficient inductive voltage be developed to cause the load to ignite the neon tube. Several surge tubes of the gas type are available on the market and may be applied readily.

ECHO CAMERA USED IN SEARCH FOR OIL



The search for oil is carried on with modern methods through the use of an earthquake echo camera which records sound vibrations from an underground explosion. Herbert Hoover, Jr., is shown examining the geophysical recording oscilloscope or echo camera.

DESIRABLE SELECTIONS

TURBINE UNITS (A.C.)

UNIFLOW UNITS (A.C.)

DIESEL UNITS

4 VALVE UNITS (A.C.)

DIRECT CURRENT UNITS

BOILERS (A.S.A.C.)

POWER PLANT EQUIPMENT CO., INC. 30-41 CANTON STREET NEW YORK CITY, N. Y.

Harr-Sabreath Machinery Company
52 Water Street Pittsburgh, Pa.

McBRIDE & McCLENNEN

DELTA EQUIPMENT CO.

Metal Tools
Air Compressors
Engine Generators
Electric Motors
Pumps
Cut Costs by Saving Time

WANTED
BY MANY INDUSTRIES
CORROSION-RESISTING
TUBING
COMPARABLE TO SEAM-
LESS IN PHYSICAL
CHARACTERISTICS BUT
AT A LOWER PRICE

ELECTRIC MOTORS

SELLING
OPPORTUNITIES
OFFERED-WANTED

PHANTOM BENTLEY

TYMAN-MICHAELS COMPANY

WANTED

BRAWN Monel Tubing is the answer to this "want ad." By Pressure Brazing spiral Monel strip and then Cold Drawing it to required diameters we produce a tubing which approximates seamless in tensile, compression and bursting strengths. Better still, its manufacture is accomplished with far less labor, time and waste—savings that are passed on to the user with the result that Brawn Tubing has found quick favor with designers who are necessarily working on a limited budget... Glad to send you testing samples and quotations. Write us.

SUPERIOR TUBE COMPANY
Norristown, Pa.



ALSO MAKERS OF FINE SMALL SEAMLESS TUBING IN VARIOUS METALS AND ALLOYS AND LOCK-SEAM CATHODE SLEEVES UNDER U.S. PATENTS

BRAWN MONEL TUBING
BRazed-drAWN

Clare Presents

NEW TYPE "A" - A.C. RELAYS

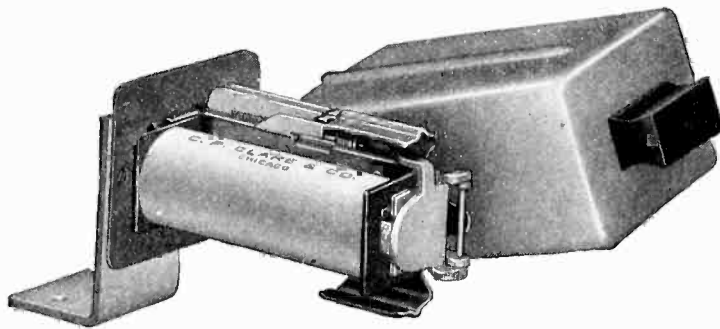

Write for descriptive catalog.



Featuring —

Laminated core * Impregnated coil * Efficient low loss magnetic circuit * Multiple contact assemblies (large selection of forms available) * Contacts; selection of welded silver, palladium and tungsten, in various sizes up to $\frac{3}{8}$ " diameter * Mounting dimensions, interchangeable with Clare Types C, D & E—DC relays.

Providing —

Efficient quick operation * No "contact bounce" * 6 to 220 volts AC—20 to 60 cycle operation * Long life * Low current consumption.

C. P. CLARE & CO.
LAWRENCE & LAMON AVES. - - CHICAGO
15 EAST 26TH STREET, NEW YORK CITY

High-vacuum Oil Diffusion Pumps

WITH the aid of new low-vapor-pressure fluids and apparatus of unique design*, extremely low pressures and high pumping speeds are now made possible.

Pump	Pressure Obtainable†	Backing Pressure	Speed at 10 ⁻⁴ mm.	Price, f.o.b. Rochester, N. Y.
All-glass, single-stage	10 ⁻⁵ mm.	.08 mm.	3 1/s.	\$ 36.00
All-glass, 3-compartment, 2-jet	5 x 10 ⁻⁷ mm.	.20 mm.	12 1/s.	123.00
All-glass, 4-compartment, 3-jet	5 x 10 ⁻⁸ mm.	.20 mm.	15 1/s.	180.00
Glass Booster	10 ⁻³ mm.	1.0 mm.	3 1/s.	96.00
Glass-metal, high-speed	5 x 10 ⁻⁶ mm.	.15 mm.	220 1/s.	120.00

* All pumps and pump oils are protected by patents granted and applied for.

† Measured with an ionization gauge at 25° C., without the aid of a cold-trap.

Inquiries are invited regarding molecular distillation apparatus, high-vacuum pumps, low-vapor-pressure fluids, and other aids to high-vacuum technology.

DISTILLATION PRODUCTS, INC.
ROCHESTER, N. Y.

Candid Camera X-Ray

A NEW METHOD of producing instantaneous X-ray exposures has been announced by the Westinghouse X-Ray Company in connection with a new X-ray machine intended primarily for chest examinations. In such work it is necessary to have a short and intense exposure in order that the motion of the heart may not affect the radiogram from which the diagnosis is made. Power is obtained from a 110-volt line, is rectified, and charges a bank of condensers whose capacity is adjustable by the exposure control. The condensers attain full charge in approximately 8 seconds. When the full charge is attained, an increase in the temperature of the X-ray tube filament permits the discharge of the energy through the X-ray tube.

While the condensers are charging, the X-ray tube filament is kept at so low a temperature that no current can flow through it. This is accomplished by a series of resistances connected to the filament, which limits the filament current to 2½ amperes, the value at which no electronic conduction occurs.

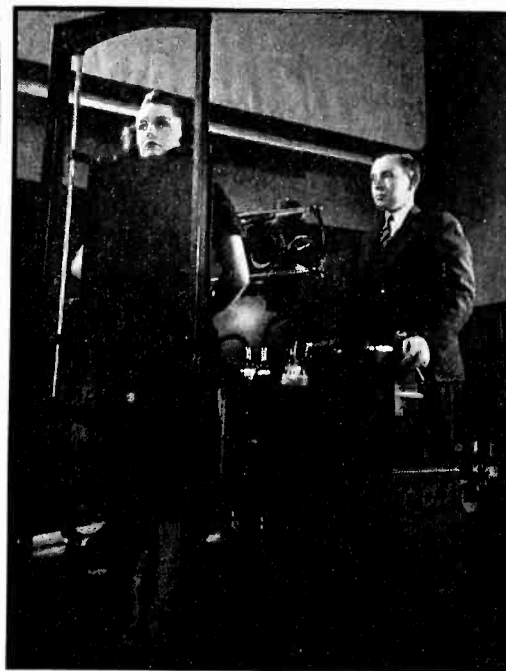

Called a "candid x-ray camera" because of its compactness, this unit takes exposures in 1/100th second

When the discharge is desired a ballast lamp is shunted across the series resistor. The ballast lamp has a low resistance when cold but a high resistance when hot. When initially shunted across the resistor, the low resistance of the ballast lamp permits a filament current of approximately 6.5 amperes to initiate the current flow suddenly. To prevent excess emission the ballast lamp heats up and reduces the filament current to the correct value for exposure of 4.5 amperes. When the condensers are completely discharged the exposure is automatically terminated. Duration of the exposure is approximately one one-hundredth of a second.

AUTHENTIC TELEVISION REVIEW

IN THE MARCH ISSUE OF ELECTRONICS

The March ELECTRONICS television review — preceding by a month the inauguration of broadcasting — marks the experimental and design engineers' collective bow to production, the release from lab-

oratory to public of a great new art. It will tell the reader what is here—what is coming. It will show in advertisements where products are procurable.

ADVERTISERS POINTING THEIR PRODUCTS TOWARDS TELEVISION SHOULD PUT THEIR SALES MESSAGE IN THIS MARCH ISSUE —

Because:

it will be read—editorial and advertising—by **ALL** of your important product prospects.

ELECTRONICS, with its *net paid* circulation of more than 13,000, is your only means of penetrating to unknown television design headquarters, getting to that man or those men who make purchase decisions.

ELECTRONICS has played an important part in this television development from its inception — always awake to the potentials of this patiently perfected electronic idea. It has published authentic articles consistently for years (more than 65 pages of television material in 1938 alone).

These progressive articles on the engineering development of television have been guided to ELECTRONICS readers by editors well known as consultants in the field — experimenters themselves who have kept up with television by building television components and sets in the ELECTRONICS laboratory.

Needless to say, after the March issue, ELECTRONICS editors will continue to maintain the lead in authentic information on this new art; not as a matter of opportunism, but as a continued service to its readers.

PUT YOUR SALES MESSAGE IN ELECTRONICS

THE ELECTRON ART

Each month the world's technical literature is scanned to see what physicists and engineers are doing with tubes, for presentation in tabloid form to *Electronics'* readers

The Future of Television

GENERAL INFORMATIONAL articles on television appear to be in the limelight these days. The December 31 issue of *Business Week* contained a 14-page article, "1939—Television Year," by Donald G. Fink, managing editor of *Electronics*. This issue had hardly come off the press when the January issue of the *Journal of the Society of Motion Picture Engineers* appeared containing an article, "The Road Ahead for Television," by I. J. Kaar, of the General Electric Co., at Bridgeport, Conn., where a considerable amount of television work is being done, especially in so far as this relates to television reception.

The author's summary states: "Now that television standards have been agreed upon in the United States, commercial receiving sets will undoubtedly be available very soon, and regularly

scheduled television programs may be expected at the same time. How good will the television be and what are the problems yet to be solved before television reaches the technical maturity that radio has today? These are questions of considerable interest to engineers in related fields, and are the subject matter of the present paper. The quality of present-day television pictures is compared with that of motion pictures both in the theatre and in the home. A discussion is given of the problems that have been found to make television what it is today, and consideration is given to the problems that must be solved to make television what we hope it will be tomorrow. The problems of signal propagation and interference are discussed, and the matter of network program distribution is considered. A short introduction is given to the commercial problems in television.

ATOM SMASHING TUBE

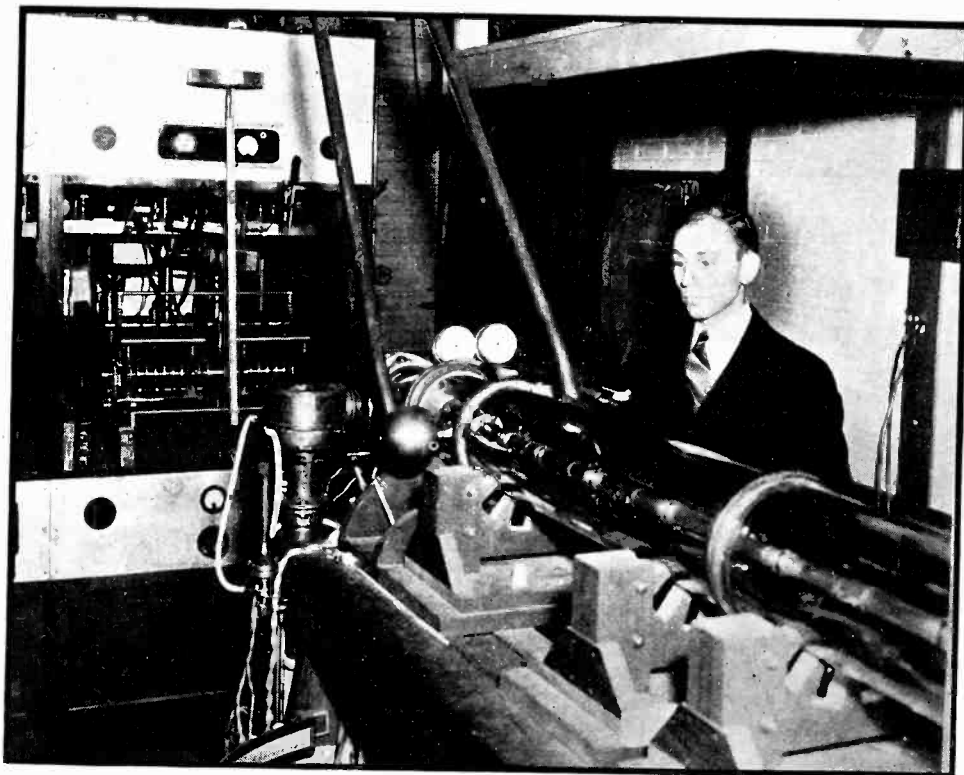

Dr. Lloyd P. Smith, professor of physics at Cornell University, shown with a vacuum tube six inches in diameter and eight feet long designed for studying the structure of the atom. The tube uses ultra high frequency radio oscillations to accelerate light and heavy atoms at the target at one end of the tube where the atomic particles are disintegrated.

Wide Range Oscillators

A BEAT-FREQUENCY oscillator, having a frequency range from 5 to 1600 kc., and a maximum power output of 10 watts is described by A. C. Hall, under the title "A Wide Range Beat Frequency Oscillator," in the January issue of the *Review of Scientific Instruments*. The frequency-output curve of this amplifier shows that throughout the range of 5 to 1600 kc., the output variation is less than $\frac{1}{2}$ of 1 db.

The constant frequency oscillator, which is of the electron coupled type, operates at 8 mc., and the variable frequency oscillator covers the frequency range from 8 to 9.6 mc. The two oscillators are coupled directly into a type 956 acorn pentode frequency converter and the resultant mixed voltage is amplified in two stages of amplification, the output stage of which uses two 6L6 tubes.

A schematic wiring diagram of the oscillator, together with circuit constants is given, and an analysis is given of the coupling circuits which are required to produce a uniform frequency-output response curve.

Television Image

By B. SHEFFIELD

TELEVISION RESEARCHERS find themselves debating several burning questions regarding the factors which determine the acceptability of television images. Some of the major problems along this line are discussed from the points of view of physics, physiology and psychology, in "The Television Image" published in *Telefunken Hausmitteilungen* of September 1938 (Volume 19 No. 79, pp. 23-35). In this paper, Dr. F. Schroeter, the author, arrives at the following conclusions:

1. From the points of view of psychology and esthetics, absolute image size is not a decisive factor in combined television and sound broadcast reception.

2. From the points of view of physics and physiology, home television screen dimensions, for a 441 line interlaced image, should not exceed 31 by 26 cm (12.4 × 10.4 in.)

3. At present, large, and particularly projected, images (441 lines interlaced) are of value only in large rooms and in connection with proportionately extended viewing distances.

4. The normal contrast range in modern television tubes satisfies all requirements, provided that stray light is excluded from the vicinity of the screen. Where stray light interferes, the brightness level in interlaced images is limited by flicker.

5. Normal receiver noise levels and the necessity of maintaining sharp contrast in the received images demand that small light amplitudes are expanded at the transmitter and compressed again at the receiver.

6. In rooms with interference from the lighting system the most satisfactory tone color is produced by screens which fluoresce with strong white and

some blue. A purely white color, and a complete contrast range, are obtainable by using complementary filters.

7. Colored, and possibly three dimensional, reproduction is of greatest value at present in television pictures. Later on both of these special types of images may gain in importance in home television broadcasting as well.

8. Since television can be considered the optical counterpart of audio broadcasting, it calls for high fidelity acoustical reproduction to be acceptable, just as the success of sound motion pictures and the justification for their existence as an entity depend upon the quality of silent motion pictures considered by themselves.

9. Television is significant primarily for extending ordinary optical limits of rooms and thus enabling large audiences to witness distant events as they are taking place. Such events may of course consist partly of film showings, as for example trailers of motion picture premieres, or of illustrated lectures.

• • •

THE "VODER" SPEAKS FOR ITSELF



The first machine to artificially create the spoken word was recently demonstrated at the Franklin Institute by members of the Bell Telephone Laboratories. The "voder" synthesizes speech from hisses and tones generated by vacuum tube equipment. By means of a foot pedal and organ-like keys, the sounds are produced, mixed, and controlled by a dexterous operator to produce monosyllables, words, and complete sentences. Stanley S. A. Watkins is shown operating the synthetic voice while Robert R. Riez and Homer W. Dudley look on.

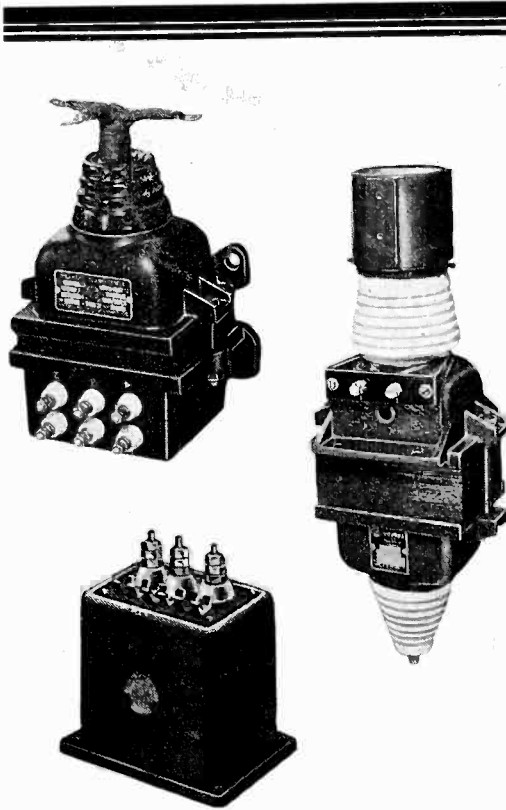

Thinking About FILAMENT TRANSFORMERS?

FILAMENT transformers can do more than provide a source of low voltage for your tube filaments—use of the proper type for each application permits simplifying the construction of your apparatus, improving its appearance, increasing the efficiency and safety factor and reducing the cost. Investigate the possibilities offered by AmerTran's new line which contains nearly 200 standard listings for popular tubes from which to make a selection. Conventional types for all tubes are available in seven different test voltage ratings. The line also includes scott-connected units for three-phase circuits and transformers with the tube socket mounted on the high-voltage bushing to simplify your wiring. All types are vacuum-varnish impregnated and have compound-filled mountings, ceramic terminals and primary taps. May we send Bulletin 14-5?

AMERICAN TRANSFORMER CO.

178 Emmet St.,



Newark, N. J.

AMERTRAN

AMERTRAN ELECTRONIC PRODUCTS

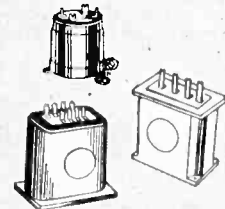

AUDIO FREQUENCY COMPONENTS

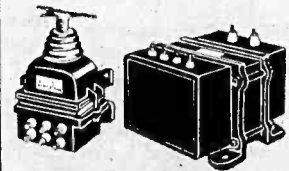

AIR INSULATED RECTIFIER COMPONENTS

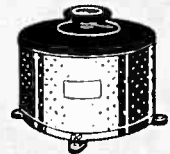

MANUALLY OPERATED VOLTAGE REGULATORS



LINE EQUALIZERS

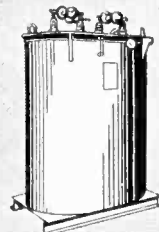

OIL IMMERSED TRANSFORMERS

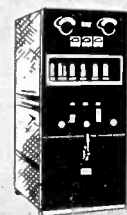

RECTIFIERS

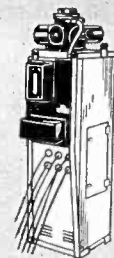

AUTOMATIC VOLTAGE REGULATORS

S.S. White **MOLDED RESISTORS**

The "All-Weather" Resistors

- AMONG THE USERS**
- Radio Corporation of America
 - RCA Manufacturing Co., Inc.
 - RCA Communications, Inc.
 - General Electric Co.
 - Westinghouse Elec. & Mfg. Co.
 - Automatic Electric Co., Ltd.
 - Bartol Research Foundation, Franklin Institute
 - R. S. Hart — Moisture Gauge
 - Merck Institute of Therapeutic Research
 - National Technical Laboratories
 - Roller-Smith Company
 - General Talking Pictures Corp.
 - National Broadcasting Co.
 - Pan American Airways, Inc.
 - Railway & Industrial Engineering Co.
 - U. S. Army and Navy
 - Griffith Observatory
 - Air-Track Manufacturing Corp.

... 1,000 OHMS TO 1,000,000 MEGOHMS

Full details and illustrations in **RESISTOR BULLETIN 37**
Free copy with Price List sent on request. Write for it.

NOISE TESTED

At slight additional cost, resistors will be supplied individually "noise-tested" to this specification: "For the complete audio frequency range, resistors shall have less noise than corresponds to 1 part in 1,000,000." (For values up to 10 megohms)

S. S. WHITE

The S. S. White Dental Mfg. Co.
INDUSTRIAL DIVISION

Department E, 10 East 40th St., New York, N. Y.

WHAT ENGINEERS LIKE ABOUT CINAUDAGRAPH SPEAKERS

What engineers like about Cinaudagraph Speakers is the even, high quality of tone and dependability of construction. Furthermore Cinaudagraph offers this fine quality in a complete line of permanent magnet and electro-dynamic speakers from 5" to 18". Investigate the new profit possibilities of comparatively priced Cinaudagraph speakers used so extensively by the country's foremost manufacturers of radio and Public Address equipment.

Write to Cinaudagraph Corp., Stamford, Conn., for new descriptive catalog today.



CINAUDAGRAPH CORPORATION
STAMFORD, CONNECTICUT

Starting Mercury Vapor Tubes

IN THE NOVEMBER issue of the *Journal of Applied Physics*, Carl Kenty of the General Electric Vapor Lamp Company, presents a paper, "On the Starting of Hg Vapor Discharge Tubes," of which the following is the author's summary.

In a commercial method of starting the Cooper Hewett Hg vapor lamp, a current of about 0.7 amp. is first made to flow in a circuit containing an inductance and a mercury vacuum switch for "shifter". This shifter is then opened magnetically and the resulting arc therein is unstable and begins to go out. But the inductance acts to keep the current flowing and develops a high voltage which is impressed as a negative kick of about 1,000 volts in the average case of starting, on the mercury pool cathode of the main tube. This kick, as a result of the action of a strip of tinfoil on the outside of the cathode bulb surrounding the mercury pool edge and connected to the main anode, starts the arc. The whole process results in the transfer of nearly the entire current from the shifter arc to the main arc in a current of the order of a few microseconds. The initiation of the cathode spot is attributed to the

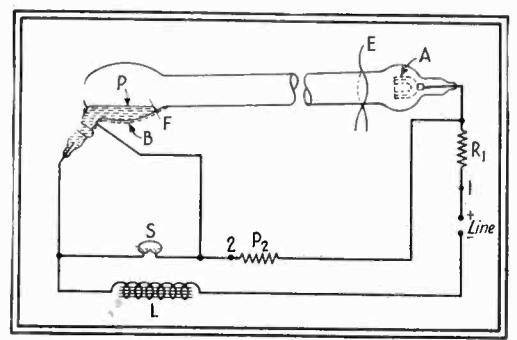

Schematic wiring diagram of circuit for starting mercury vapor tubes.

action of the high electric field at the mercury pool edge existing between this edge and the tinfoil on the outside of the glass. In accord with this theory is the fact that anything which can be done to cause the mercury to wet the glass at the pool edge at a number of points (thereby increasing the field) such as by baking a little carborundum powder on the glass at the edge, helps starting enormously.

If the anode of the tube is disconnected, simple electroscopes show that the walls of the tube everywhere become charged to a negative potential of the order of 10,000 volts as a result of the kicks. High speed electrons are thus evidently shot up the tube. Ionization produced by these probably forms the beginning of the positive column. After the initiation, the current in the tube rises to a maximum at a rate limited by the inductance in the circuit and then decreases to a low value sometimes going out altogether. This decrease is shown to be due to an extreme deficiency of mercury vapor in the tube caused by the electrical cleanup of mercury on the walls. Violent

voltage surges set in across the tube at this time and a hissing noise is heard. The region of aggravated low pressure can be seen as glowing weak and red-dish compared to the blue white of the rest of the tube. This appearance vanishes, as a result of the rising vapor pressure due to heating, the hiss and surges stop. The surge period may endure many seconds in cold weather before the arc is able to pick up.

Radio Field Intensity Measurements

A REPORT on the attainable accuracy of radio field intensity measurements at radio frequencies below and within the broadcast band is given in a joint paper (in the December issue of the *Bureau of Standards Journal of Research*) by Harry Diamond and E. G. Lapham of the Bureau, and K. A. Norton of the Federal Communications Commission. Accurate measurement of the intensity of the field set up by broadcast stations is essential for evaluating their service areas. The report presents an analysis of the types of errors encountered in typical commercial field intensity measuring sets, and gives quantitative data on the magnitudes of the errors. Based on these data an estimate is made of the overall absolute accuracy of commercial equipment. Before applying correction factors for the several errors, the accuracy of measurement may be

NEWS FACSIMILE

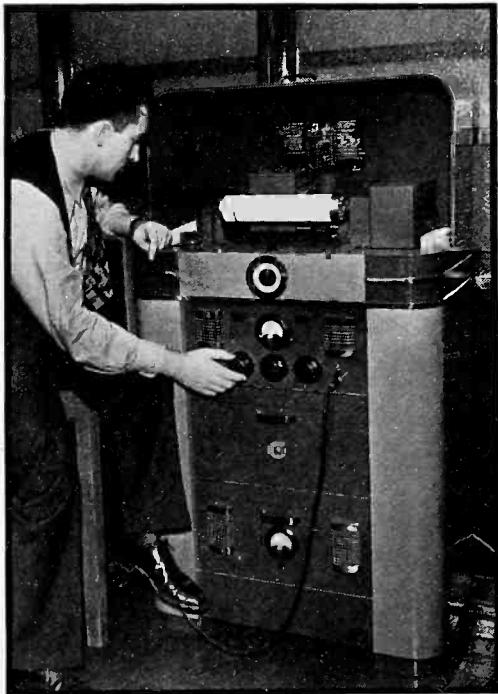

Transmitting apparatus used by station W9XYZ, experimental radio facsimile broadcasting station operated by the St. Louis Post Dispatch. The first radio edition, sent to 15 members of the station's staff, consisted of nine pages eight and one-half inches long and four columns wide, using standard newspaper 7 point type

This is the Spot-

and the Firm Name

Struthers Dunn, Inc.

to be remembered when, as, and where you might need any type of

Electrical Controlling Device

whether one or thousands—special or standard.

This company builds its controls into your design or product—to take care of the job exactly as you want it done—in other words—built to your order.

Our engineers—our workmen—our office force are organized and trained for this type of work and service.

Allow us to figure on your requirements and note "the difference".

STRUTHERS DUNN, INC.

148 N. JUNIPER STREET

PHILADELPHIA, PA.

DUNCO Electrical Control DEVICES

More than an accessory—an improver of prestige, dependability and performance

You are PAYING for these finer instruments

... why not HAVE them?

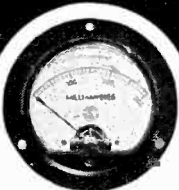

3" Round. Model 25-S for D.C.; 55-S for A.C.



3" Rectangular. Model 27-S for D.C.; 57-S for A.C.



Fan shaped. Model 22-S for D.C.; 52-S for A.C.

SIMPSON Panel Instruments give you those first essentials of a permanently accurate instrument — bridge-type construction with soft iron pole pieces. And they give you this finer, more costly construction at prices no higher than you may be paying for ordinary construction.

This unprecedented value is founded on the experience of Ray R. Simpson, formerly president of Jewell Electric Instrument Company, and a staff of instrument-builders who have been associated with him for many years. Long experience and modern methods have combined to make highest quality at moderate prices a reality.

Write for bulletin

Ask for a new bulletin describing ten models covering a wide scope of ranges and types. These finer instruments are also the basis of the advanced line of Simpson Test Equipment, two typical models of which are illustrated opposite.

SIMPSON

INSTRUMENTS THAT STAY ACCURATE

SIMPSON ELECTRIC CO., 5212 Kinzie St., Chicago, Ill.

Use SIMPSON Testing Instruments

Model 202



There is a Simpson Testing Instrument for every need. The Model 202 "Roto-Ranger", Volt-Ohm-Milliammeter with twelve independent, automatically changing scales, is illustrated above. Below is shown the Model 230 — the smallest pocket type A.C. and D.C. Volt-Ohm-Milliammeter.



Model 230

Ask for latest bulletins

Send for this

RELAY DATA

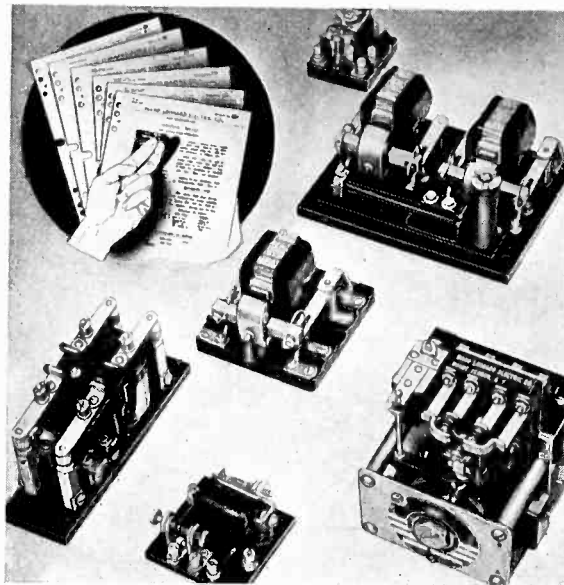

describing midget, intermediate, and heavy duty, sensitive type, time delay and motor driven relays in all contact combinations.

WARD LEONARD

ELECTRIC COMPANY

32 SOUTH STREET

MOUNT VERNON, N. Y.

Electric Controls Since 1892

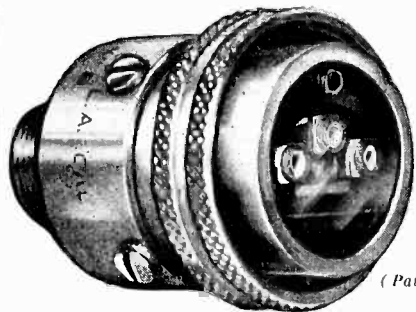

Cat. No. SK-L3-21-3/8R

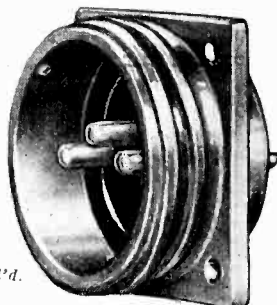

Cat. No. SK-L3-32SL

(Pat. App'd. for)

Full-size Detail of CANNON Switching Receptacle and Plug with Automatic Grounding Device Housed in Receptacle, Face of which is of Transparent Plastic Exposing the Mechanism.

Automatic Grounding Device Housed in "Safety Socket"

CO-OPERATING with leading aircraft manufacturers in the solution of a safety problem, the Cannon Company has just developed a Cable Connector that does "double duty" for safety's sake. Paradoxically, the Connector is always operating whether connected or disconnected. To put it simply, the receptacle mechanism automatically switches the internal circuit when the plug is withdrawn.

Developed for the protection of aviation ground crews working near propellers, the new CANNON switching receptacle is placed in the magneto circuit to insure positive grounding of the "mag" when the plug is removed from the socket, after the motor is stopped. Thus the ignition circuit is inoperative and an accidental movement of the propeller cannot start the motor with consequent disastrous results to anyone in the propeller's path of travel.

The development of this Connector illustrates the highly specialized service offered to Cannon clients. Though designed primarily for aviation, the new Connector is adaptable for many uses in other fields. Descriptive Bulletin now available. Other Bulletins list over 1,000 Cable Connector fittings which are pre-eminent in the fields of Sound, Aeronautics, Geophysical Research, Ship-Control and Laboratory Panels.

Please specify your requirements when requesting Bulletins.

CANNON ELECTRIC DEVELOPMENT CO.

★ 420 West Avenue 33, Los Angeles, California

★ EASTERN SALES OFFICE, 220 Fifth Ave., New York, N.Y.



CANNON PLUGS

no better than about 20 per cent. After application of suitable correction factors, an accuracy of 5 per cent may be attained.

Factors likely to lead to errors in field intensity measurements in typical equipment include: (a) incorrect calibrating voltage; (b) non-linearity of the detector and of the output indicator system; (c) incorrect voltage-attenuator design; (d) incorrect balance of the loop antenna; (e) stray voltages induced in the loop antenna by the calibrating oscillator or from other portions of the set; (f) regeneration in various portions of the set; (g) distortion of the field by the set container or by mounting of the loop antenna on an automobile; and (h) the difference in effect of distributed capacitance of the loop antenna upon its voltage step-up for the distributed field voltage and for a lumped calibrating voltage.

The distributed capacitance effect appears to have been given scant consideration in the design of commercial apparatus. The error produced is a function of the ratio of the operating frequency to the natural frequency of the loop antenna. In some commercial sets in which the loop antenna operates near its natural frequency to reach the upper broadcast frequencies, this error reaches a magnitude of 15 per cent. The report includes a theoretical analysis of this error and presents derived correction factors to be applied in order to obtain more accurate measurements. The correction factor is shown to be a function of the current distribution in the loop antenna, which is, in

• • •

ATOMIC-PHYSICS OBSERVATORY

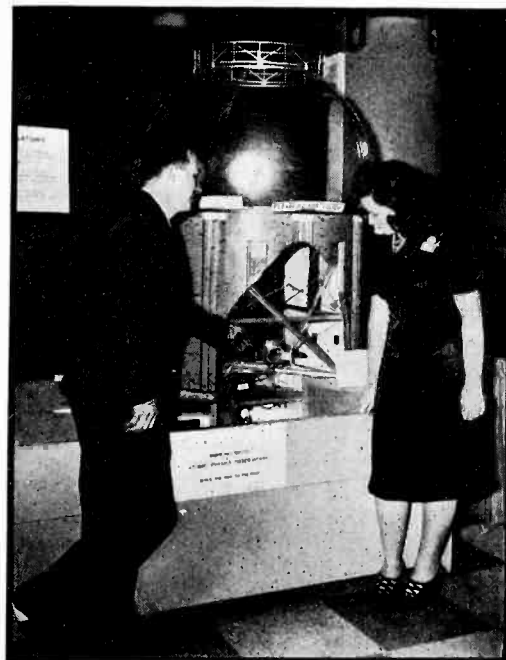

At the recent meeting of the American Association for the Advancement of Science, Dr. M. A. Tuve, demonstrates a working model of an atomic-physics observatory for carrying on research at the Carnegie Institution.



TWO FAVORITES in Crystal Pickups

In Models B-10 and O-7, Astatic Engineers provide the field of sound reproduction with crystal pickups of the highest type designed for professional use and radio phonograph combination installations, respectively. Both include Offset Head and other improved features. Full year guarantee.

B-10 List Price.....\$17.50
O-7 List Price.....\$6.50



ASTATIC
MICROPHONE LABORATORY, INC.
Youngstown, Ohio
Licensed Under Brush Development Co. Patents

"JAGABI" RHEOSTATS

are quality devices for fine adjustment and control of electric current. We regularly carry in stock 76 standardized ratings, and a variety of special types is available.

Write for descriptive Bulletin 1515-E, which includes interesting technical data on how to select fine adjustment rheostats.

JAMES G. BIDDLE CO.
ELECTRICAL INSTRUMENTS
1211-13 ARCH STREET PHILADELPHIA, PA.

turn, a function of the distributed capacitance. Four assumptions of current distribution are considered, and corresponding correction factors are derived. The factor derived on the basis of elliptical current distribution is shown to have better basis in theory, and agrees closely with experimental measurements.

Finally, several means are described for eliminating or limiting the distributed capacitance error by special design of the set. These include the use of the condenser-variation method for measuring the voltage step-up of the loop antenna, the use of an untuned loop antenna wherein no voltage step-up is involved, the use of a shielded loop antenna having an unbalanced current distribution, the deliberate unbalance of the two halves of the loop antenna for covering the broadcast band so that no antenna operates near its natural frequency.

Included in the report is a discussion of the precautions necessary in obtaining accurate field intensity measurements when the measuring set is installed in an automobile, a practice adopted by many engineers.

...

More on Combination Tones

AS A RESULT of the article, "Combination Tones in Non-Linear Distance" by Frank Massa in the September issue of *Electronics*, we have received from Thomas C. McFarland, associate professor of electrical engineering at the University of California, a pamphlet dealing with similar trigonometric expansions. This pamphlet, "Table for Power Series Calculations Involving Independent Variables of Two Harmonic Components" is available from the University of California Press, Berkeley, Calif. In these tables, the power series is carried out to the thirteenth power and charts have been devised whereby the expansion may be carried out to any desired degree.

...

World Radio Convention Papers

AS HAS BEEN reported in *Electronics*, the Institution of Radio Engineers (Australia) organized a world radio convention in Sydney from April 4 to April 14, during which technical papers were presented by well known scientists, engineers and executives. More than fifty papers were delivered at or were contributed to the convention, covering a wide range of subjects.

A limited number of bound volumes of the proceedings of this convention has been made available for engineers who desire a complete technical file of the meetings held in Sydney. Communications should be addressed to O. F. Mingay, General Secretary, 30 Carrington St., Sydney, Australia.



Silver Band DYNAMOTORS

SMOOTH QUIET DEPENDABLE

"PINCOR" offers the only complete line of "B" power supply equipment for police units, aircraft and radio broadcast service and sound systems. Available in a wide range of frames, sizes and capacities to fit any particular requirement.

"PINCOR" dynamotors are the last word in efficiency and regulation. Deliver high voltage current for proper operation of your apparatus with a minimum of A. C. ripple. These units will give years of smooth, quiet, satisfactory service. They are compact, light weight. Available with or without filter. Send coupon for catalog.

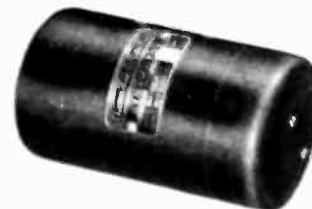

PIONEER GEN-E-MOTOR CORP.
Dept. R-4B
466 W. Superior St., Chicago
Export Address
25 WARREN ST.
NEW YORK, N. Y.
U. S. A.



Send for FREE Copy Today!

.....
PIONEER GEN-E-MOTOR CORPORATION
Dept. R-4B, 466 West Superior St., Chicago, Illinois
Without obligation kindly send me "PINCOR" Silver Band Dynamotor catalog and data sheets.
Name
Address
City State

THE INDUSTRY IN REVIEW

A New Unidirectional Microphone

By BENJAMIN BAUMZWEIGER

Development Engineer, Shure Brothers

ANNOYING effects of reverberation and background noise, which are almost invariably present in microphone setups may be greatly minimized, if not entirely eliminated, with a microphone sensitive only in the direction of the desired sounds and relatively insensitive in other directions. The importance attached to directional properties of microphones even in the early days of broadcasting and public address is evident in many attempts to use various kinds of reflectors and baffles to increase directional discrimination. Correctly designed microphone baffles are capable of producing some useful high-frequency directivity. However true unidirectional operation is unobtainable by such means inasmuch as diffraction effects become pronounced only at wavelengths considerably smaller than the important dimensions of the obstacles. The inability of such devices to cope effectively with the majority of microphone pickup problems becomes evident if it is remembered that the bulk of the acoustical energy is transmitted in the frequency range below 1000 cps.

True unidirectional operation can be obtained with a combination of a pressure-type microphone and a velocity-

type microphone. This is analogous to the well-known unidirectional antenna array consisting of a vertical element and a loop. The voltage in a pressure-type microphone is independent of the direction of incidence of sound, while that of the velocity-type microphone reverses with the reversal of incidence. Outputs of the individual units therefore add for sounds arriving from the front and subtract for sounds arriving from the rear. Through careful design, substantial output cancellation is obtained for rear sounds throughout practically all of the acoustical frequency spectrum.

This procedure, although simple and straight-forward theoretically, has a number of practical drawbacks. The frequency response curves as well as the phase positions of the individual voltages must closely correspond in order to obtain an acceptable front-to-rear discrimination at all the important frequencies. The correspondence required, in view of difference in operating principle of the units, necessitates elaborate and expensive selective processes to achieve proper matching of the units, which naturally is reflected in the high prices which such microphones command.

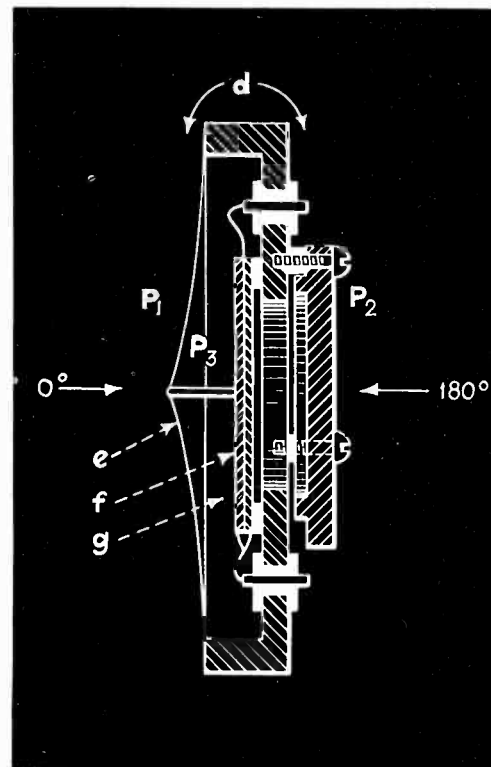
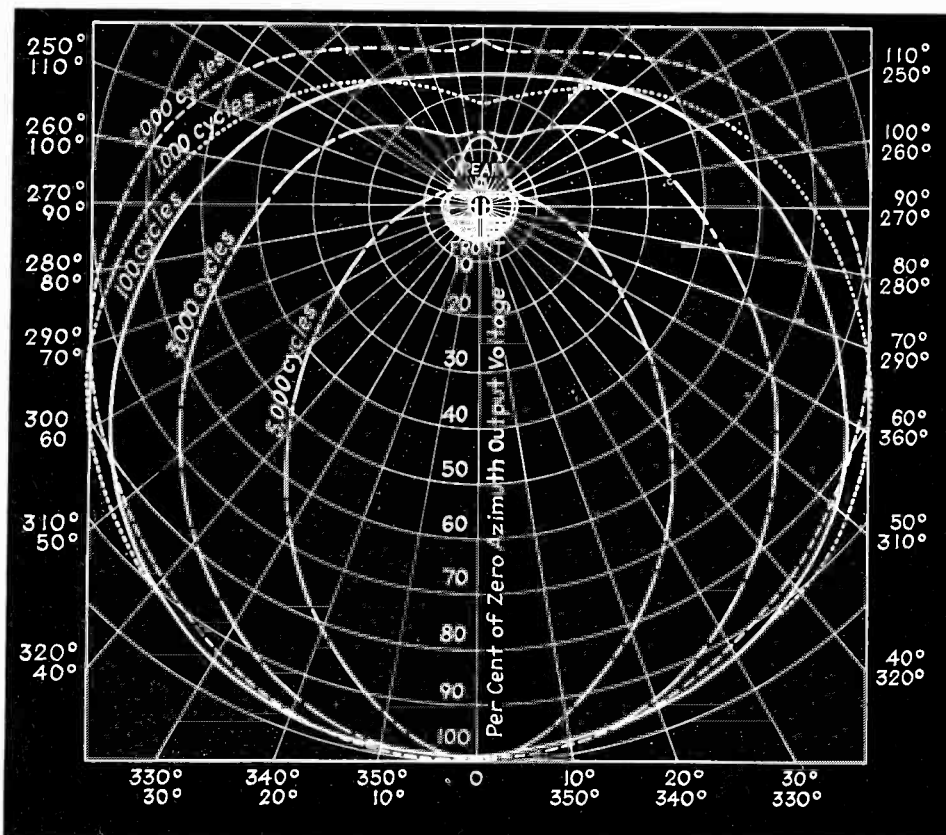

Fig. 1—Cross sectional view of the new Shure Brothers microphone, showing the essential component parts. This is a crystal-type unit

A new principle of unidirectional operation employing only one microphone unit was developed some time ago in the Shure laboratories, and has been embodied in the Model 730A "Uni-

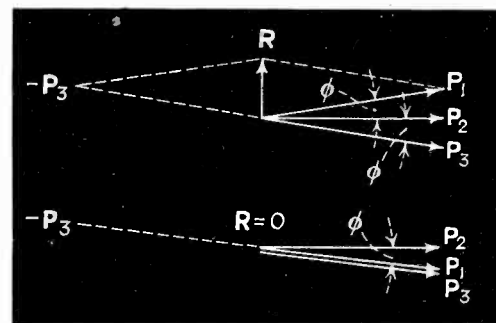

Fig. 2a (above) and Fig. 2b—Manner in which unidirectional microphone action is attained

Fig. 3—Cardioid-shaped directivity pattern of the "uniphase" mike, given for several audio-frequency values

plex" Unidirectional Crystal Microphone. The new unit achieves unidirectional operation through the use of phase-shifting acoustical networks coupled to a diaphragm-type crystal element. The simplified structure obtained this way obviously has a number of technical advantages arising from the purely acoustical nature of the system. A cross-sectional view of the unidirectional mechanism is shown in Fig. 1 illustrating the essential component

(Continued on page 78)

♦ **DR. S. J. BEGUN** has joined the engineering staff at The Brush Development Co., Cleveland, O. He was formerly connected with Acoustic Consultants, Inc., and with Guided Radio Co., New York City . . . Roller-Smith Co., New York City announce the consolidation of its executive offices with its Works at Bethlehem, Pa., where all activities of the Company will be concentrated . . . **H. E. LeRoy**, RCA Victor, has been appointed Manager of the Company's reorganized Special Apparatus Mfg. Div., **A. L. Piper** becomes executive assistant to the Vice President in charge of Engineering and Research, and **H. C. Shepard** heads the Standardization Dept. . . . Cinema Engineering Co., has moved from Hollywood to Burbank, Cal., where they will have new and larger quarters . . . **E. W. Seeger** is now Chief Engineer and **P. B. Harwood** is Assistant Chief Engineer of Cutler-Hammer Inc., Milwaukee, Wis. Both men are holders of numerous patents and inventions dealing with electric motor control . . . A complete standard line of transformers and other equipment of Robert M. Hadley Company is being put into production at their new plant in Newark, Delaware, thereby expanding their service in the East . . . **Edward Wallerstein**, formerly sales manager of RCA-Victor, has been appointed President of American Record Corp., a subsidiary of CBS . . . **Franklin Clark**, formerly with Westinghouse, now is Assistant Electrical Engineer for the Duro-Test Corp. of N. Bergen, N. J., where he is developing the Company's new "screw-socket" fluorescent lamp . . . Duro-Test Corp., announced a stock dividend equal to 4% was declared payable on March 1st to stockholders of record . . . United Transformer Corp. has moved to new and larger quarters at 150 Varick St., New York City . . . RCA is planning to revise its exhibition plans at the Fair in order to increase the scope and effectiveness of the television presentation . . . Presto Recording Corp., has moved offices and equipment manufacturing plant to 242 W. 55th St., New York City.

Literature

Straight Facts About Television. Contained in "A Miracle Begins" by Dr. W. R. G. Baker, General Electric Co., 570 Lexington Ave., New York City.

Tube Manual. 1939 Catalog & Manual lists new transmitters and circuits, technical information, and tubes, of Taylor Tubes, Inc., 2341-43 Wabansia Ave., Chicago, Ill.

Radio Noise Data. "Filterette Catalog" describes products for noise elimination. Tobe Deutschmann Corp., Canton, Mass.

Steel Panels. Industrial Ovens, Dryers and Casings also described in bulletins of Falstrom Co., Passaic, N. J.

Coaxial Cables. Complete information including characteristics. Transducer Corp., 30 Rockefeller Plaza, New York City.

Transmitter Components. Apparatus for high voltage rectifiers. Prices and data listed. American Transformer Co., 178 Emmet St., Newark, N. J.

4 in. Square Instruments. Catalog 48-a describes ammeters, milliammeters, microammeters, voltmeters, single and polyphase wattmeters, and pyrometers. Roller-Smith Co., Bethlehem, Pa.

Ignitron Tubes. Described in "Information Bulletin" No. 17. Westinghouse Elec. & Mfg. Co., Lamp Division, Bloomfield, N. J.

Auto Antennas. New 1939 models described in one-page bulletin, Form 4095. RCA Mfg. Co., Camden, N. J.

House Organ. "G-M Comments" includes information on galvanometers, phototubes, power supply units, and rheostats. G-M Labs., Inc., 1733 Belmont Ave., Chicago, Ill.

New Products

New Tubes

HYGRADE SYLVANIA CORP., 500 Fifth Ave., New York City, announce receiving tubes as follows: Types 884 and 885, gas triode hot-cathode control-grid types; Types 1852 and 1853, television amplifier pentodes.

RCA MFG. CO., Harrison, N. J., announced two new cathode-ray tubes, 1803-P4 kinescope (12 in.) and 1804-P4 kinescope (9 in.) both electromagnetic-deflection types with white phosphor. 2V3G, high voltage half-wave rectifier. Other tubes are new Acorn types: 957, detector, amplifier, oscillator; 958, A-F amplifier, oscillator; and 959, detector, amplifier pentode.

ARCTURUS RADIO TUBE CO., Newark, N. J., have several new tube types: Type 2Y2, and Type 5X3 are half-wave, high-vacuum rectifiers; 6AD5G high mu triode designed for a high vacuum sweep oscillator or amplifier; and Type 6R6G remote cut-off pentode amplifier.

Test Equipment

THREE NEW PRODUCTS have been announced by Radio City Products, Inc., 88 Park Place, New York City: A combination tube and set tester, Models 800 and 800-A, which measures d-c and a-c voltage and current, ohms, decibels, and condenser leakage; a universal multi-tester, Model 409-A, which measures ohms, amperes, and volts; and a signal generator for servicemen's needs.

Electronic Relay

AN ULTRA-SENSITIVE electronic relay, Type 850, of Advance Electric Co., 1260 W. 2nd St., Los Angeles, Cal., has a contact combination of single pole, double throw, single break, using silver contacts rated at 1.5 amps, 110 volts. The relay will operate on 14 milliwatts, and by close adjustment on 4 milliwatts. A desirable feature is an easily accessible adjustment screw which makes possible an adjustment whereby the relay will fall out of contact at 30% less voltage than that required to make contact.

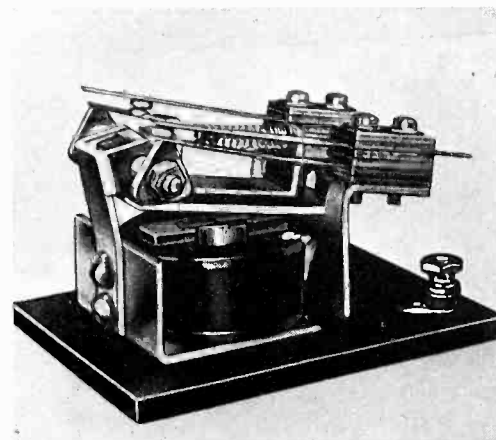

ALSO ANNOUNCED is Type 900 impulse relay which entirely eliminates the necessity for placing coils in continuous operation. The pawl, mounted on an armature, is actuated by a momentary electrical impulse and in the downward stroke of the armature, it engages the ratchet, moving the cams one position on each impulse. Contacts have a maximum carrying capacity of 30 amps at 6 volts and 10 amps at 115 volts on non-inductive loads. Multiple switch combinations and coils are available for either a-c or d-c.

Hearing Aid

A VACUUM TUBE unit which is compact, simple, and light is the new device "Otophone" of Otophone Inc., 152 W. Wisconsin Ave., Milwaukee, Wis. It operates on 1½ volts flash light battery with a total drain of 180 ma and 45 volts B with 0.2 ma drain and a net output of 60 db. It has good frequency response and is non-directional.

Mobile Unit

MOUNTED UPON three separate chassis which plug-in to mechanical fastenings in a shockmounted weatherproof case are a 15 watt crystal controlled transmitter and a noise suppressed superheterodyne receiver, and a receiver power supply. Plug-in connecting cables permit the changing of either chassis, without tools. The line consists of 15, 50, 100, 250, and 500 watt stations for police, fire and forestry communication with mobile units. Radio Engineering Labs., 35-54 36th St., Long Island City, N. Y.

High Fidelity Receiver for Local Reception

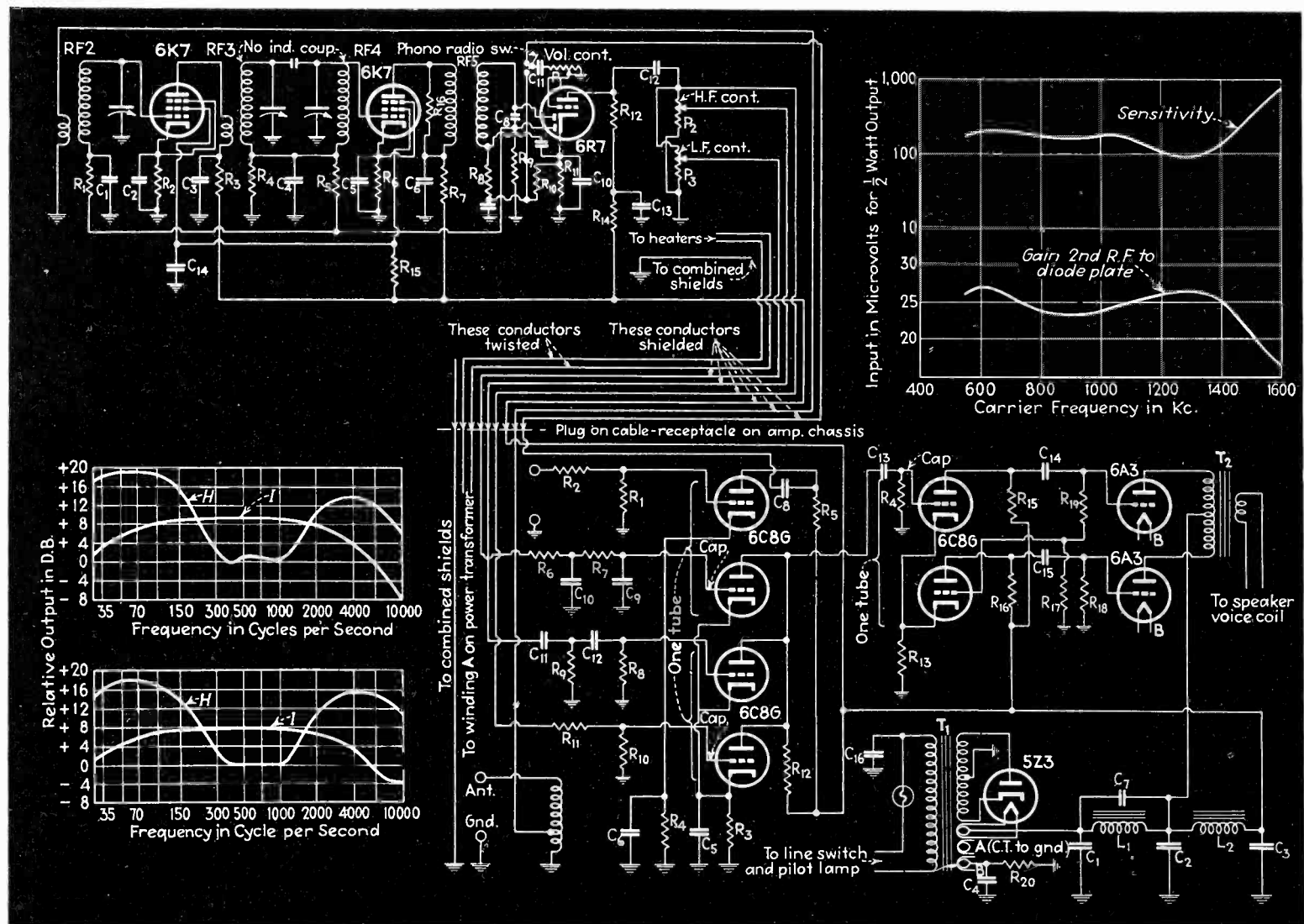

Circuit diagram, and characteristics, of the Pacent local receiver designed for wide-band reception. It will be sold complete or in knock-down kit style for home or shop construction. In the insets will be noted on upper right the sensitivity in input required for one-half watt output, and below, gain in db, second r-f grid to the diode plates. On the left are, above, the electric fidelity from antenna to 6-ohm

load, and below the electric fidelity from the phonograph input to the 6-ohm load. In both curves, the "H" line represents both high and low compensation controls at maximum; "I" curve represents tone controls at minimum. The tuning mechanism is connected to the amplifier and power supply by a 25-ft cable through which all tone, volume, tuning control wires pass making the unit remotely controlled

ON THE theses that (1) a special receiver is required to produce signals satisfactorily from distant stations; (2) a special receiver is required to produce high fidelity signals from any station; (3) a receiver which is both high fidelity and a good distance getter will be quite expensive, Pacent Engineering Company, New York City, has developed an inexpensive (\$125 list) receiver primarily for high fidelity reception from fairly strong local stations.

This receiver will be sold complete, or as a kit which the user or service man may put together.

It is a t-r-f circuit with just enough selectivity to avoid interference in areas like that in New York City and an acceptance characteristic such that frequencies off resonance by 8 kc will not be down more than can be compensated in the a-f network. The r-f gain is suffi-

cient, to bring in near-by stations and there is enough a-v-c to prevent blasting when tuning from one station to another. The a-f amplifier has sufficient output for home use; and the high-low and middle frequencies may be adjusted separately and over a wide amplitude range. The entire characteristic (including the loud speaker and enclosure) does not vary more than 10 db over the range 40 to 8000 cycles.

The set is built in two parts, the tuning mechanism and the amplifier. They are connected together by 25 ft. of flat strap cable. The tuner is small (8x6x4 in. over knobs) and contains all controls including bass and treble. The amplifier may be installed out of sight and although there are recommended dimensions of loud speaker cabinet the speaker may be installed in the wall, in a door or in any other place where sufficient baffle area is provided. The speaker

is a Cinaudagraph HY12-12 PM.

As may be seen from the circuit diagram, there are two r-f stages. After a conventional antenna stage, the r-f stages are connected by a band pass type of coupling in which the plate is inductively coupled to the first tuned circuit which is coupled to the second circuit by capacitance only. The second stage connects to the diode detector via an untuned transformer. Separate amplifier elements are provided for the bass, the middle tones and the treble. A maximum bass boost of about 18 db and a treble boost of 14 db are provided. The output tubes are push-pull 6A3's and deliver 10 watts to the voice coil of the speaker. One set of triode elements in a 6C8G tube is used to reduce the impedance of a crystal phono pick-up to a value suitable for use on the line to the tuner. Nine tubes in all are required for the receiver.

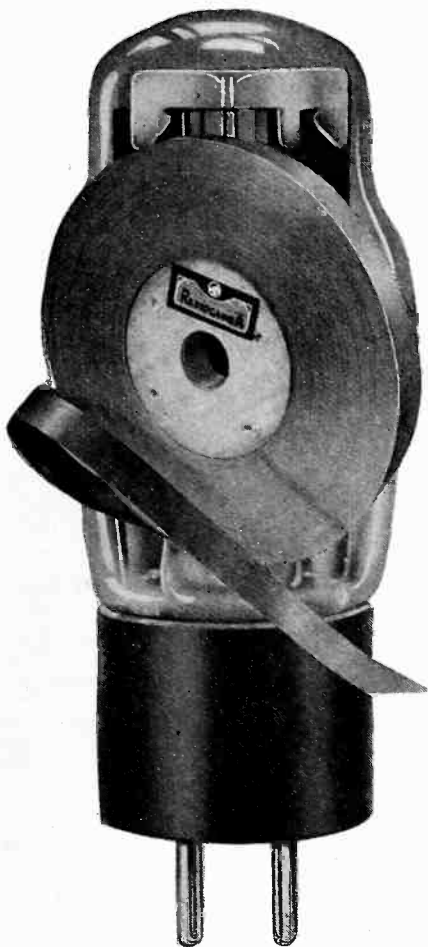

The ultimate in Radiation
WILBUR B. DRIVER CO.
 NEWARK, NEW JERSEY

PLUGS — SOCKETS
 TERMINAL PANELS, ETC.

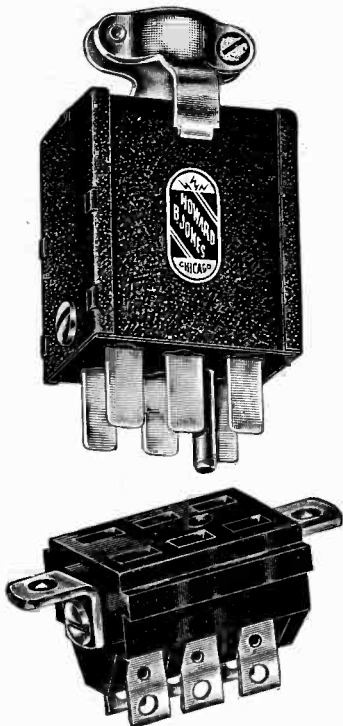

ILLUSTRATED
 PLUG: P-6-CCT—SOCKET: S-6-AB

HUNDREDS OF STANDARD ITEMS
 OR SPECIALS TO YOUR BLUE-
 PRINTS.

WRITE FOR BULLETINS.

HOWARD B. JONES
 2300 Wabansia Avenue
 CHICAGO ILL.

Dual-Diversity Receiver

TWO IDENTICAL RECEIVERS on the same chassis, are gang-tuned for single control and utilize a single r-f oscillator for both channels resulting in higher average level signal. The AVC systems of the two channels are interconnected so that when one signal fades badly in one channel the other takes control of both. A 3 position switch permits either channel to be used alone, or the two in combination. Continuous coverage from 540 kc to 46 Mc is provided in six bands selected by push-button.

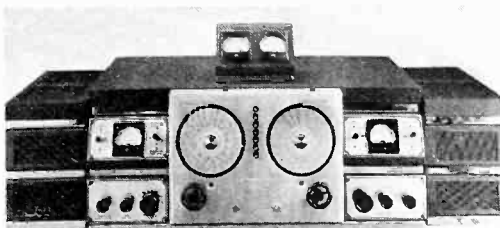

TABLE TYPE transmitter, Model HT-1 is self-contained and provides 3 band, crystal controlled operation with a carrier power of 100 watts on cw and 50 watts on 'phone. A band-change switch provides complete, instant changeover. Products are of Hallcrafters, Inc., 2611 S. Indiana Ave., Chicago, Ill.

Microtrol Relay

HOUSED IN A WEATHERPROOF case, automatic, ultra-sensitive controller, self-contained, Model 705 input relay, will operate on values from 2 microamps up and from 0.5 millivolt up. The power relay contacts will handle 5 amps at 110 volts a-c non-inductive. Weston Electrical Instrument Corp., Newark, N. J., designed it for door opening, smoke alarms, temperature control, etc.

Battery Eliminator

SPECIALLY DESIGNED for use with farm radio and low-power transmitters, Model J, an A-B power supply, operates on any 6 volt storage battery, wind charger, etc. It provides 1½ or 2 volt "A" power and "B" voltages of 45, 67, 90, 135, and 180 volts at 40 ma. It is operated directly and automatically by the radio receiver switch. Electro Products Labs., 549 W. Randolph St., Chicago.

Portable Lamp Grip

"SNAP-GRIPP" developed by Safeguard Electric Co., 1 DeKalb Ave., Brooklyn, N. Y., is a metal lamp guard. Two halves of a cage are held together by snapping the ends of two semi-circular bands which form the lower construction of the metal cage. Two sizes available, up to 60 watts and up to 100 watts.

FACILITIES for SPECIAL Adaptations

of Electrical Instruments
 at very
MODERATE COST

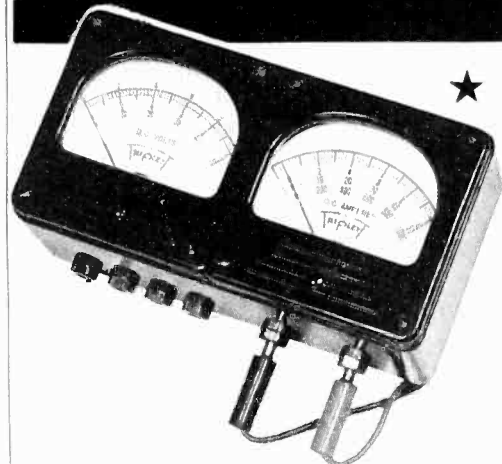

★ Special Twin: separate 3" D.C. ammeter and 3" D.C. voltmeter with special range requirements assembled in strong molded case. External jack connection.

Industrial and engineering requirements continually call for special applications of electrical measuring instruments if greatest efficiency is to be obtained in laboratory, shop or field use.

Frequently, too, a rearrangement of the panel is the easiest and least costly way to bring the appearance of a tester or machine model up-to-date.

Triplet is equipped to give any kind of service in electrical measuring instruments quickly and economically. The wide Triplet line in instruments, cases, molds and tools and dies may offer you a solution at a fraction of your estimate of costs. Our engineers are men of long specialized training and experience, and they will be glad to work out your individual applications and designs. Why not write us?

Triplet manufactures a complete line of electrical measuring instruments embracing round, square, rectangular; molded and metal cases and twin meters for radio, electrical and general industrial applications.

WRITE FOR CATALOG



The Triplet Electrical Instrument Co.
 232 Harmon Ave., Bluffton, Ohio

Please send me more information on
 Special Twin; Send Catalog

Name
 Address
 City

WTAM Gets Aluminum Gas-filled Coaxial Transmission Line

New line connecting transmitter with tuning house at base of antenna. Below, crew at installation. James McGowan, Richard Marshall, Charles Braglio of the Aluminum Co. of America; William S. Duttera of NBC; C. K. Strausbaugh of Raybould Coupling Co.; Richard Gourlay, Aluminum Co., and H. G. Beebe, Isolantite Inc.

THE first commercial application ever made of aluminum for gas filled coaxial cable is the new antenna transmission line just completed at NBC's broadcasting station, WTAM, in Cleveland. This new type aluminum cable was installed in connection with WTAM's new 470-foot vertical radiator which is expected to increase the station's coverage and insure much greater audibility over a forty per cent larger area in northern Ohio.

Aluminum Tubing Used as Conductor

Use of aluminum tubing in place of copper in gas-filled coaxial transmission lines represents a radically new departure in radio practice. According to Isolantite Inc., who developed the new line in collaboration with engineers of the Aluminum Company of America, aluminum effects marked savings in weight and cost without any sacrifice of necessary electrical properties. The new line is strong and rugged, and is comparable with copper in corrosion resistance and life factor.

An interesting feature, unique in electrical applications of aluminum, is that the tubing used is of approximately the same dimensions as the copper required for the same service. In most electrical applications it is necessary to increase the area of the aluminum in inverse ratio to the conductivities of the two metals, to obtain the same total resistance. This necessity does not arise in coaxial line because of the high frequencies at which the line is used. Here the impedance is the important factor rather than the resistance, and at the frequencies employed the impedance is composed of a large reactance vector and a comparatively small resistance vector. An increase in the resistance therefore has only a negligible effect on the total impedance.

New Type Gas Tight Connectors

Coincidentally with the development of the aluminum cable, Isolantite announced the use of a new connector which eliminates all need for soldered

joints, simplifying the installation of the line. The connector permits the forming of gas-tight joints of high tensile strength by a simple process of tightening bolts.

In this connector the pressure necessary to maintain a tight seal is applied axially, the bolts being parallel to the tubing, and is converted into radial pressure on the engaging members. When the bolts are tightened, tapered surfaces exert upon a compressible member, such as rubber, pressures so high as to establish a fluid pressure relationship. This fluid pressure is transmitted to metal bands which engage the ends of the tube sections, and which

are of non-flowing characteristics at the pressures encountered. The metal bands are slotted to permit engagement with the tube walls. Because the rubber acts as a fluid, practically all the pressure is transmitted to the metal bands; and is evenly distributed to give the fullest degree of engagement. The rubber also serves to form a seal at any point at which the bands are not in complete engagement. This method of connection gives a joint of higher tensile strength than is possible where rubber is used directly as the engaging medium. The metal bands engage with the tubing to form a circuit of very low resistivity.

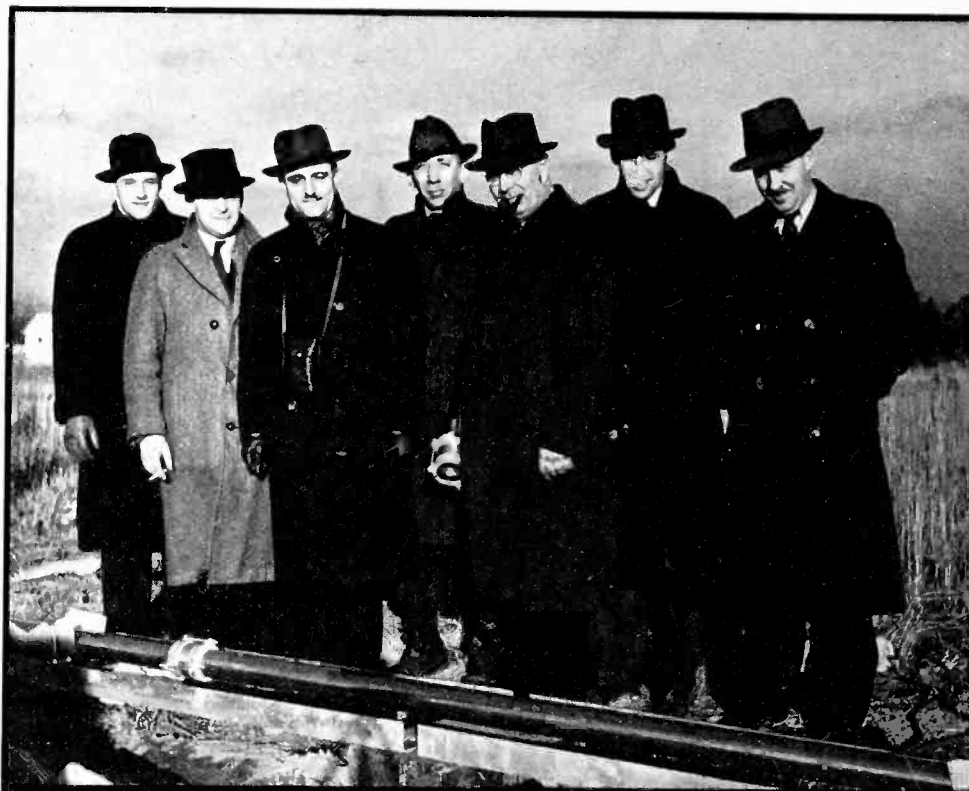
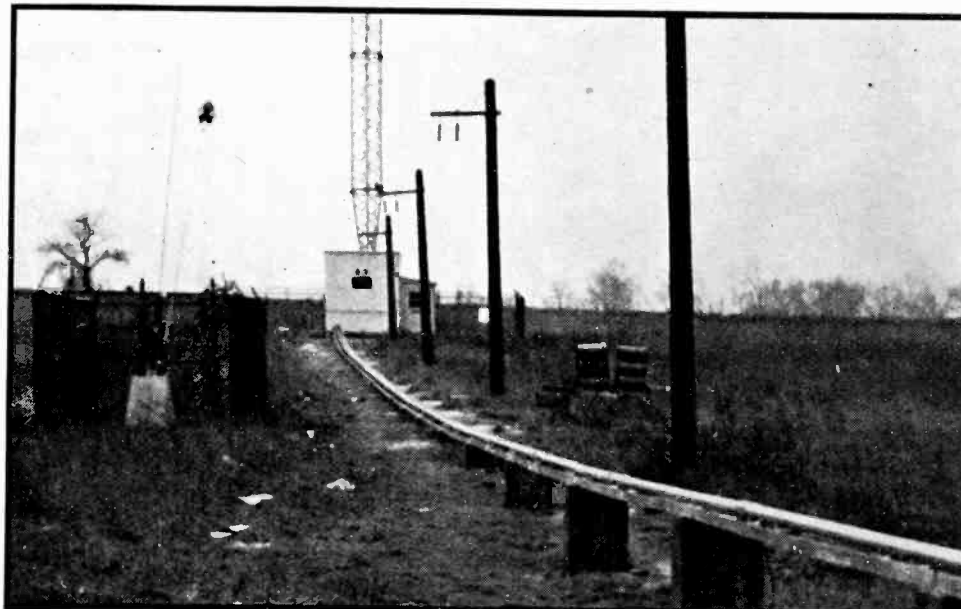

Speak-O-Phone

MODEL 1-50 OF Speak-O-Phone Recording and Equipment Co., 23 W. 60th St., New York City, is compact and portable (weighing 34 lbs.) and can serve as an electric phonograph or as a PA system for broadcasting voice or music through a microphone; a collapsible stand which can be used as floor stand, desk, or for banquet purposes; the amplifier has 3 stages with a response of from 100 to 10,000 cycles, an output of 4 watts; meter for monitoring volume level; dual volume control switch for controlling volume of recording and playback; an outer rim drive adjustable tension motor with constant speed at 78 rpm for recording from outside in, operating on 110 volts a-c. A permanent diamond cutting needle is provided for aluminum discs.

A-C Relay

TYPE "A" SENSITIVE and control relays of C. P. Clare & Co., Lawrence & Lamon Aves., Chicago, incorporate the following features: low loss magnetic circuit, quick acting, no "contact bounce", quiet operation, numerous contact arrangements, long life, and low

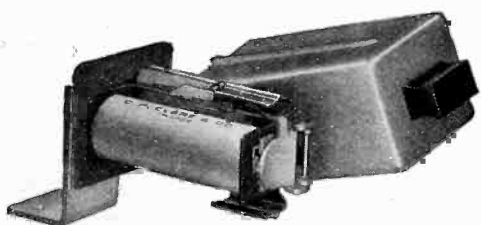

current consumption. Contacts (welded to the springs) are available in silver, palladium, platinum-iridium, and tungsten, and may be had in sizes up to $\frac{1}{8}$ ins. in diameter. Literature is available.

Oscillograph Wobbulator

MODEL 830 IS A 3 in. cathode-ray unit with a built-in frequency-modulated 1000 kc oscillator announced by the Triumph Mfg. Co., 4017 W. Lake St., Chicago. Alignment of t-r-f circuits is obtained by the resonance curve method and over-all analysis of a-f amplifiers by generating a signal which changes in frequency from 0 to 10,000 cycles, 60 times per sec.; the resulting pattern on the oscillograph shows the amplitude characteristic of the audio amplifier under test. A-f response of amplifiers or audio coupling units may be instantaneously tested over any band of frequencies between 0 and 25,000 cycles. The unit is small (weighs 22 $\frac{1}{2}$ lbs.). A thyatron sawtoothed sweep circuit provides a continuous range of 7 to 30,000 cycles while a 6SJ7 amplifier tube will achieve an input sensitivity of 0.4 volts RMS per inch.

ALSO ANNOUNCED is a new tube tester, Model 430-LX, which tests the new 7 and 35 volt tubes and pilot lights.



DEPENDABLE

CAPACITORS

FOR EVERY RADIO AND ELECTRICAL USE

GOOD CAPACITORS are fabricated from such ingredients as "long experience," "quality materials," and "the integrity of the maker." Much could be said about any one of these "components" as it is found in C-D capacitors. Cornell-Dubilier prefers to let one word—"DEPENDABLE"—do the talking. For in the radio and electrical industries, C-D has come to mean "Capacitor Dependability." So long as C-D appears on the capacitor you buy, you can be sure the vital ingredients are there—in good measure.

For complete description of the entire C-D capacitor line, write for Cat. No. 160.

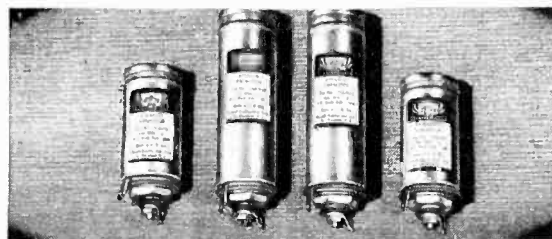

Type TLA Dykanol Filter Capacitors available in a wide capacity range at 600, 1000 and 1500 V.D.C.

CORNELL-DUBILIER
ELECTRIC CORPORATION
South Plainfield, New Jersey

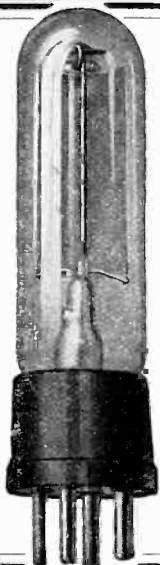

CETRON PHOTOCELLS

Set a Standard
By Which All Photo Tubes Are Judged

76 DIFFERENT TYPES AVAILABLE

OUR ENGINEERING DEPARTMENT IS ALWAYS READY TO ASSIST YOU IN YOUR DEVELOPMENTS.

Write for Literature

CONTINENTAL ELECTRIC COMPANY
HAMILTON AND RICHARDS STREETS, GENEVA, ILL.

Heavy Duty, Hi-Power Genemotors

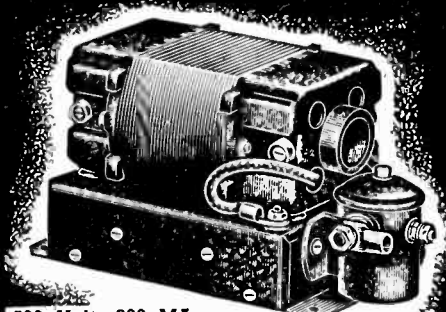

500 Volt, 200 MA.
(Motor Only, 7"x4"x2 $\frac{7}{8}$ "—Weight 10 lbs.)

For Hi-Gain Amplifiers, Ultra Short Wave Two-Way Police Radios, Aircraft Radios, etc. Six years of successful performance.

There is a Carter Genemotor for every requirement.

SMALL SIZE—NO HASH
LIGHT WEIGHT—RELIABLE
Write for Complete Information

CARTER MOTOR CO.

1608 MILWAUKEE AVE.

CHICAGO, ILL.

An Unbeatable Pair

THE
DU MONT
TYPE 185
ELECTRONIC
SWITCH
AND
TYPE 168
CATHODE RAY
OSCILLOGRAPH

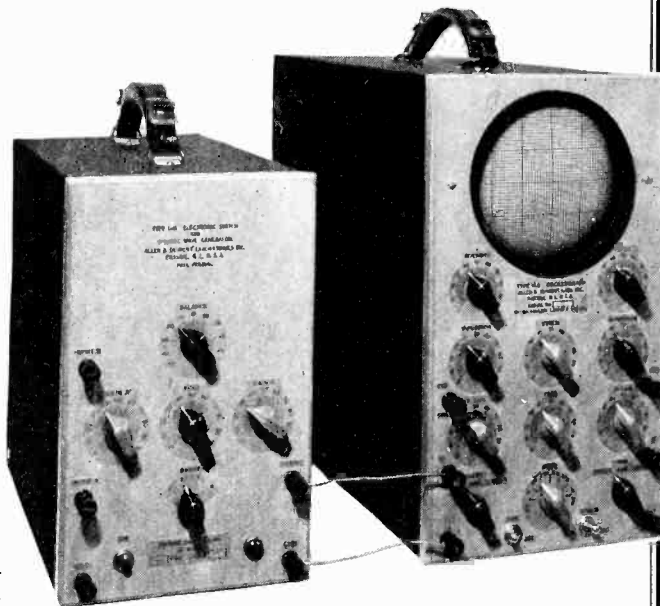

The Du Mont Type 185 Electronic Switch, operating to cause two independent signals to appear superposed on the screen of the cathode-ray oscillograph, offers many new possibilities for definite critical comparison of two independent signals.

The Type 168 Cathode-Ray Oscillograph, a long-time favorite among flexible laboratory instruments, again proves its usefulness in its ready adaptability to this new and complex problem.

ALLEN B. DU MONT LABORATORIES, INC.

Passaic, New Jersey

Cable Address: Wesplexin, New York

BLILEY CRYSTALS

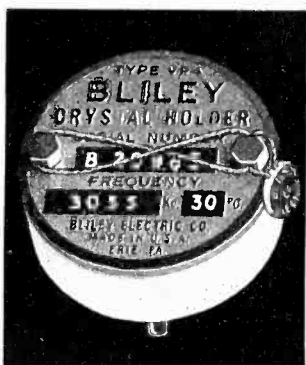

are manufactured for all frequencies from 20 Kc. to 30 Mc. Precision holders and ovens are available for standard and special applications. Bliley Broadcast Frequency Crystals are approved by the F.C.C.

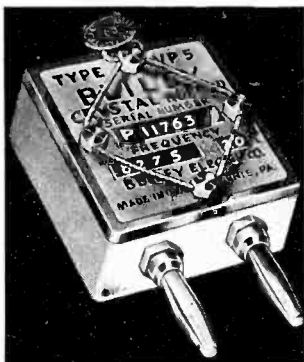

BLILEY ELECTRIC CO., ERIE, PENNA.

LEACH LR RELAYS

you can depend upon their
OPERATING RELIABILITY

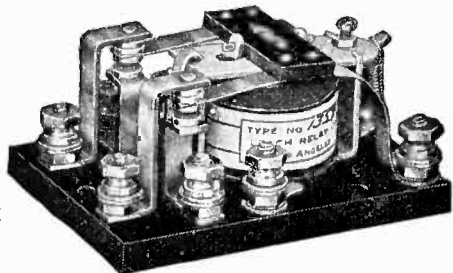

TYPE NO. 1357

Leach small size circuit control relay, type No. 1357 is a compact, rugged and reliable control relay ideal for your control circuit. These relays have solid cores, positive contact and low current consumption—built so that you can depend upon them!

LEACH RELAY COMPANY

5915 Avalon Boulevard, LOS ANGELES, CALIF.
15 E. 26th St., New York City

LEACH RELAY COMPANY, 5915 Avalon Boulevard, Los Angeles, Calif.

Please send your catalog. I am interested in..... type relay.

Name
Company
Address City

Ohmmeter

THE INSTRUMENT IS a multi-range ohmmeter having ranges from 0.2 up to 300 megohms and is designed for use where resistance measurement requirements call for extremely broad coverage plus constancy in operation. Model 763, of Weston Elec. Instrument Corp., Newark, N. J. can be used on the top range as a modified "megger" wherein 125 volts (Maximum current microampers) is available for insulation test. A filament type vacuum tube is used as a rectifier in order to supply the 125 volts needed for the 300 megohm range. It is operated from an a.c. 60 cycle supply, and can be operated without variation in results because of the line voltage control, on a.c. circuits with a voltage with 105 to 130.

Foot-Candle Meter

NEW IN DESIGN, the "Photomet" is a super-sensitive foot-candle meter or exposure meter capable of measuring light intensities as low as 0.0005 fc. is an item of G-M Labs., Inc., Chicago, Ill., and is applicable for lighting surveys, colorimetry, light absorption studies, reflection factor measurements, photomicrography, and photoengraving. It is self-contained and consists of a self-generating Visitron cell.

Spot Welder

A SPOT WELDING machine with hydrogen gas to prevent oxidation, discoloration, corrosion, and brittleness, has been developed by Eisler Engineering Co., Inc., 750 South 13th St., Newark, N. J. An automatic gas economizer and shut-off valve are so arranged that immediately after the weld is completed the gas is cut out and this gas burns at the spot only during the actual welding operation. The machine is an air operated vertical plunger type and comes in sizes from 5 KVA to 250 KVA.

Single Unit Recorder

ALLIED RECORDING PROD., 128 West 46th St., New York City, announce a 78-33½ rpm unit and which will accommodate up to 17½ in. discs. Overhead feed mechanism; high fidelity playback, 115 db amplifier, output meter; two inputs combined with a mixer—complete with BR2-S mike; and speaker.

Voltmeter

FOR USE IN CHECKING the voltage adjustment of relays, regulators, generators, batteries, and cables, Type DX-1 of General Electric Co., has been announced. It is a precision instrument with an accuracy to 2%; sensitivity is 25 ohms per volt. A meter and a hand prod included, are joined by a 30 in. durable rubber-covered wire.



for

SENSITIVITY

D.C. RELAYS

operating at four to fifty milliwatts to control A.C. loads of 150 to 1000 watts

A.F. RELAYS

actuated by telephonically applied sound to initiate control functions through other relays

ACOUSTIC SWITCHES

with sensitivity adjustable for desired response to sounds of low or high intensity

Sigma Instruments, Inc.

388 Trapelo Road
Belmont Massachusetts

Molding Compounds

TWO NEW ASBESTOS-FILLED molding materials have been made commercially available by General Plastics, Inc., N. Tonawanda, N. Y. Durez 38-443 was formulated specifically to meet Underwriters' specifications for withstanding 200° C. for 72 hours, and has an impact strength of .23 (ASTM). Heat resistance is recorded at 490° F. and specific gravity is 1.80. Durez 38-646 has a low specific gravity of 1.59; heat resistance 500° F., and impact strength .19 (ASTM). Its flexural strength is 9000 (ASTM).

Aircraft Transmitter

A 150 WATT, LIGHT weight (62 lbs.), high powered unit designated as the "Waller Communicator" has been developed and announced by The Spartan School of Aeronautics, Tulsa, Okla. It is remote controlled, covers 3 frequencies, using separate crystals for each

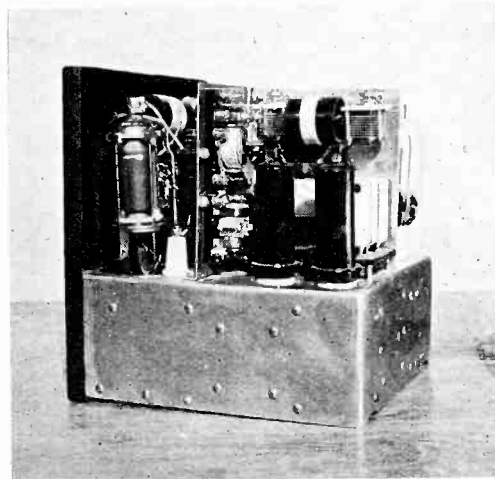

frequency; incorporates side tone, interphone, transmission on both long and short antennas, with automatic loading on the short antenna to prevent over-modulation. It delivers 150 watts into the antenna, 100% modulated, uses class "B" modulation.

Speed Controller

A MULTI-SPEED CONTROLLER for a-c motors has been announced by Raytheon Mfg. Co., Waltham, Mass. It makes possible variation of motor speed by changing the input voltage. The principal components are an auto-transformer with voltage adjustment taps and an oil filled condenser. There are no moving parts.

Acetate Shaving Collector

A VACUUM DEVICE, announced by Lake-side Supply Co., 416 S. Dearborn St., Chicago, collects the thread cuttings from recordings on acetate records and deposits them into a jar containing water thereby assuring cleanliness, and safety.

TELEVISION PRESENTS A NEW PROBLEM



The Shallcross line of kilovoltmeters, ranging from one to two hundred kilovolts, have been used for years by other branches of the electrical industry. The dependability, accuracy, and fair price of these instruments will interest you.

Let us help you with the problem of high voltage measurement. Write for Bulletin 700-KF.

RESISTANCE
RANGE FROM
1 OHM TO 10
MEGOHMS



SHALLCROSS MFG. CO.
COLLINGDALE, PA.

...DO YOUR PENCIL DRAWINGS
Ever PRINT LIKE INK?

Compare

drawn on ordinary Pencil Cloth

drawn on Yellum Paper

drawn on PENCIL-tex

POST

and you'll select
PENCIL-tex

The INK-LINE Pencil Drafting Medium

for Sharp Clean-cut detail and legibility

Photo unretouched
• All drawings made with 5H Pencil

for

- Transparency
- Drafting Speed
- Ink-dense Lines

• **INK-QUALITY**
Blue Prints or
Blackline Prints
at Pencil Speed

Ask for Attractive
TRIAL
KIT



APPROVAL of this new revolutionary Post product has skyrocketed since its recent introduction because it provides a shortcut to an INK-Quality blue print with speed, line density and contrast never before possible. It has a velvety, transparent surface that is tough, durable, subject to erasure. Made in your sizes.

JUST PHONE YOUR POST MAN
In cities not listed see your local drafting material dealer

- | | |
|--|---|
| Birmingham
James A. Head, Inc. | Knoxville
Schorn & Kennedy |
| Boston
Boston Blue Print Co. | Los Angeles
Stationers Corp. |
| Buffalo
Buffalo Blue Print Co. | Milwaukee
Frederick Post Co. of Wisconsin |
| Chicago
Frederick Post Co.
Horders, Inc. | New Orleans
Southern Blue Print Co. |
| Cleveland
City Blue Printing Co. | Oklahoma City
A. & E. Equipment, Inc. |
| Dallas
The Rush Co. | Omaha
Standard Blue Print Co. |
| Dayton
Gem City Blue Print & Sup. Co. | Philadelphia
Philadelphia Blue Print Co. |
| Denver
H. R. Meininger Co. | Pittsburgh
American Blue Print Co. |
| Detroit
Frederick Post Co. | Portland
J. K. Gill Co. |
| Fort Wayne
Fort Wayne Blue Print & Supply Co. | St. Louis
Service Blue Print & Photo Copy Co. |
| Fort Worth
Majestic Reproduction Co. | Seattle
Kuker-Ranken, Inc. |
| Houston
Gulf Blue Print Co. | Toledo
Toledo Blue Print & Paper Co. |
| Indianapolis
Indianapolis Blue Print & Litho Co. | Tulsa
Triangle Blue Print & Supply Co. |
| Kansas City
Western Blue Print Co. | |

THE FREDERICK POST CO.
Box 803, CHICAGO

INSTRUMENTS, EQUIPMENT and MATERIALS FOR THE ENGINEER and ARCHITECT. BLUE PRINT PAPERS and KINDRED SENSITIZED PRODUCTS



★
★
★

THIS SHOWS WHY OHMITE RHEOSTATS are
Unequaled in Smoothness, Permanence, Economy

SMOOTHNESS...
in operation, and
permanent closely
graduated control
are built in. Write
today for Catalog
17.

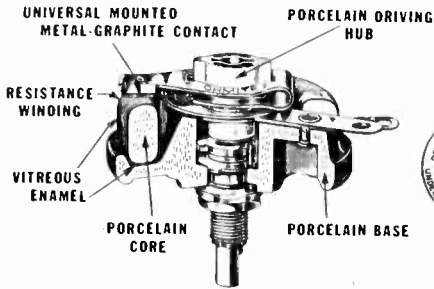

TAKE an Ohmite Rheostat—check its design and construction—then you'll know why Ohmite Rheostats are unequalled. Only Ohmite Rheostats can give you all these features: ★ Resistance wire is wound over a smooth porcelain core—held in place, insulated and permanently protected by Ohmite Vitreous Enamel. ★ Porcelain material to char or burn; no fibrous mate-

rial to shrink or change with heat or age. ★ Metal-graphite contact brush with universal mounting insures perfect contact with negligible wear on the wire. ★ Underwriters' Laboratories Listed. ★ And there are many other exclusive Ohmite features! ★ Wide range of 9 Ohmite Stock Sizes from 25 to 1000 watts—or models specially designed to your specifications.

OHMITE MANUFACTURING COMPANY ★ 4817 Flournoy Street, Chicago, U.S.A.

Be Right with **OHMITE**
RHEOSTATS ★ RESISTORS ★ TAP SWITCHES

*Explaining electron optics theory
and its most useful application:—
the TELEVISION CATHODE-RAY TUBE*

This book develops the theory of electron optics from its fundamentals and covers its application in the design of the television cathode-ray tube.

ELECTRON OPTICS IN TELEVISION

By I. G. MALOFF and D. W. EPSTEIN
Research Division, RCA Manufacturing Co.

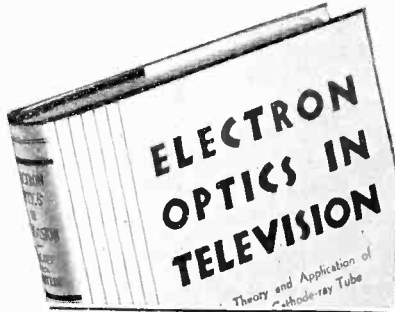

299 pages illustrated
\$3.50

HERE is a book which gives you an understanding of electron optics with applications to problems in pure and applied physics. Here are the basic principles of the design of television cathode-ray tubes and associated circuits.

Deals with the problems encountered in

designing tubes, practical and economical to construct and capable of producing satisfactory television pictures when used with practical associated apparatus. Included are approximate methods for solving non-linear circuit problems connected with the design of apparatus associated with the television cathode-ray tube.

EXAMINE IT 10 DAYS—MAIL THE COUPON

McGraw-Hill Book Co., Inc., 330 W. 42nd St., N. Y. C.

Send me Maloff and Epstein Electron Optics in Television for 10 days' examination on approval. In 10 days I will send \$3.50, plus few cents postage, or return book postpaid. (We pay postage on orders accompanied by remittance.)

Name

Address Position

City and State Company

(Books sent on approval in U. S. and Canada only.)

L. 2-39

Dynamotor

MODEL C20, WITH filter, a new dynamotor announced by Eicor, Inc., 515 S. Laflin St., Chicago, incorporates new patented features of design. The brush holder accommodates a brush of longer length and greater cross-section area and locks the brush caps, while a special device is designed to stop end play in the armature shaft. Substantial reduction in ripple voltage, lower resistance, and better regulation are obtained by the use of a stronger magnetic field permitting an armature of smaller size and weight.

ALSO ANNOUNCED is Type 3AP6, electric light plant which will light twelve 25 watt lamps or operate a standard a-c radio and eight lamps.

Attenuators

A PRECISION ATTENUATOR, announced by Ohmite Mfg. Co., 4835 Flournoy St., Chicago, is hermetically sealed in a strong glass tube to give protection against heat, humidity, etc. An attenu-

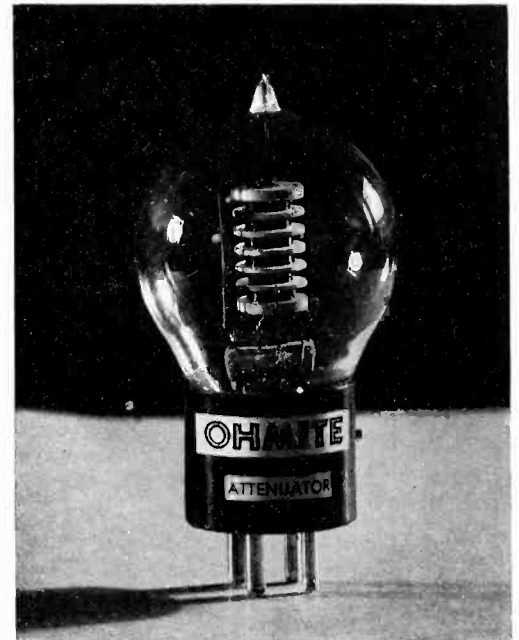

ator can be furnished to match the impedance of any line and will give any desired loss from .25 up to 40 db of infinity. It can be obtained as a "Pie", "T", "H", or "L" pad.

Vibrator

ATR VIBRATORS OF new construction have been announced by Amer. Television & Radio Co., 300 E. 4th St., St. Paul, Minn., incorporating the following features: $\frac{1}{8}$ in. tungsten contacts of full-wiping action; perforated reed of high quality Swedish spring steel; magnetic circuits with formed base; mica and metal stack spacers with 2 volt stack constructions; extra flexible leads with tinned clamp supports; precision is calibrated to hold within a tolerance of .005 of an inch. A vibrator chart and guide are available.

NA-ALD
TELEVISION
Components

WRITE FOR THE LATEST DATA ON A WHOLE SERIES OF NEW NA-ALD TELEVISION COMPONENTS.

• They are developed in collaboration with laboratories that have had the benefit of observing actual requirements revealed in field tests.

• In part, they consist of a connector for the 11-prong Cathode Ray tube—1802-P1 and 1802-P4.

• The development not only consists of meeting every requirement in the connector, but also in the attached leads. Special material and processes meet high voltage breakdown tests. (Underwriters double voltage ± 1000 .) Has complete freedom of ionization noises at operating voltages with tests at both normal and extreme humidities.

• Other components—special rectifier socket—low capacitance sockets and plugs—interlocks—high Q wire—safety grounding cords—insulated tube caps, etc. Write us just what you are doing in television so that we may keep you informed of developments that will interest you.



NA-ALD

ALDEN PRODUCTS COMPANY
717 Center St. Brockton, Mass.

**MICROMETER
FREQUENCY METER**



... a band-spread, AC-operated, heterodyne meter; ONE instrument to check several transmitters, 1.5 to 56 mc.

- **RATIO-COUPLED OSCILLATOR:** stability 5 to 10 times that of usual circuits; temperature coefficient less than 2 cycles/10⁶/°C.; line voltage effect 1 cycle per million for 1% change.
- **MICROMETER CONDENSER:** rugged cylinder-and-tube construction on regular micrometer head—no flimsy plates.
- **PRECISION DIAL:** rotates micrometer head, has 50-turn range and Veeder counter, reads to 10,000 divisions.
- **PER CENT DEVIATION CURVES:** results readily compared with FCC tolerances.

—Write today for data—

LAMPKIN
LABORATORIES
BRADENTON . . . FLORIDA

Portable Sound Systems

RCA MFG. Co., Camden, N. J., announce a 12 watt amplifier which includes two loudspeakers and a velocity microphone and is designated as model PG 112-B. 24 feet of cable is supplied with each speaker and the two-piece carrying case can be used as baffles.

TRANSFORMER CORP. OF AMER., 69 Wooster St., New York City, announce a new Clarion 15-18 watt unified system, Model C-416. Amplifier facilities include mixing, fading, tone control and multi-output impedance from 2 to 5 ohms. The unit is complete with beam power amplifier, two 10 in. speakers, floor stand, and a choice of microphone. Cables, tubes and plugs are also furnished.

Fixed Resistors

A LINE OF CARBON fixed resistors is announced by Consolidated Wire & Assoc. Corps., 520 S. Peoria St., Chicago. Of solid molded construction, permanently bonded into one compact unit, they have a tolerance or resistance variation which is maintained at a 5% average and is guaranteed within 10% \pm . They are quiet in operation, moisture proof and non-inductive, have no capacity effect, and maintain resistance values over a wide temperature range and can be used in any r-f or audio circuit.

A-B Battery Eliminator

ELECTRO PRODUCTS Laboratories, 549 W. Randolph St., Chicago, announces an eliminator that changes 110 volt raw a.c. to pure d.c. It is suitable for use with 1½ and 2 volt farm or battery operated receivers, and the power supply is sufficient for any size set. A low voltage adjuster includes switch and potentiometer, and the "A" output may be increased and diminished to provide correct "A" filament voltage to insure longer tube life.

Glow Lamp

GENERAL ELECTRIC VAPOR Lamp Co., Hoboken, N. J., announce a new ¼-watt glow lamp which is equipped with a skirted, miniature single contact bayonet base. It is of small physical size and is especially useful where space is of prime importance. No resistance has been built in the base and therefore external resistance must be limited to 2 ma.

8 Watt Amplifier

THORDARSON ELEC. MFG. Co., 500 W. Huron St., Chicago, announce a new high gain 8 watt amplifier, Model T-20W08, with a speaker case of base reflex type. This 4 tube unit features individual control of mike or phone for complete mixing, supplies 6 watts of power for field excitation and has a convenient method of selecting output impedance. Catalog 600 is available.

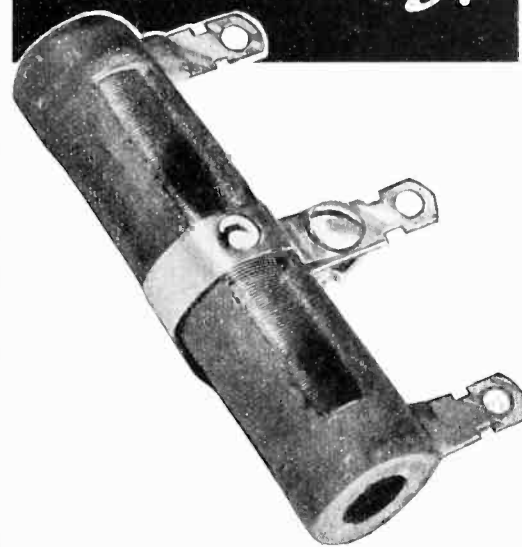

**CLAROSTAT
POWER RESISTORS**

★ Well-known commercial transmitter builder* has standardized on these units. Leading laboratory* prefers them to usual standard types. Pioneer television organization* using them in its best assemblies. All because . . .

- ★ They are more rugged. More generous overload factor. Withstand most trying service. Install them—forget them.
- ★ Entirely new inorganic cement coating. Represents years of research. Won't blister or crack even at red heat.
- ★ Quality resistance wire accurately and tightly wound on quality ceramic tubing. Imbedded in cold cement coating, unimpaired.
- ★ Maximum heat radiation means higher wattage capacity for given size.
- ★ In 10, 25, 50, 80, 100 and 200 watt ratings. All popular resistance values. Fixed and adjustable types. Also available with non-inductive winding.
- ★ Fit companions for CLAROSTAT controls, Plug-in Resistors, Strip Resistors, etc. Finished in green for positive identification.

* Names supplied on request.

Submit Your Problem . . .

★ No matter what your resistance or control requirements may be, just submit your specifications or needs. Samples and quotations cheerfully furnished.

CLAROSTAT
MANUFACTURING CO.
Incorporated
285 North Sixth St.
Brooklyn, N. Y.

United States Patents

What A Patent Lawyer Should Do For You

By H. A. TOULMIN, JR.

IT IS A common mistake to consider that a patent attorney's chief functions are merely, first, to draw up the formal application for a patent, second, to submit it to the Patent Office, and third, to represent the client in infringement suits.

A patent attorney should, as a rule, be allowed to start by making a thorough search of prior patents and the literature on all related subjects to determine the present state of the art as well as whether the invention is new. By doing a thorough job here he can often save filing expenses and, later, costly litigation, if he discovers that the idea is unpatentable because it is not new or for other reasons.

If the idea appears from this search to be patentable, he then, preferably in collaboration with the inventor, draws up the application, which requires the greatest care. In fact, the Supreme Court of the United States once commented that the application for a patent is the most difficult of all legal papers to draw up correctly.

The patent attorney then files the application with the Patent Office.

These, however, are merely the routine duties of a patent lawyer.

Before filing the application he has much more important duties to his client. He should, first, try to visualize in the invention the embodiment of a principle, plan or scheme, the broad scope of which should be protected by claims that do more than describe or define the more physical thing that has been invented.

To do this the patent attorney must understand the practical manufacturing and scientific implications of the in-

vention in its relationship to the art.

He should, further, be able to imagine how others might seize upon it and improve it with other inventions which would check-mate the original inventor unless he could arrive at some satisfactory cross-licensing agreement. He should show the inventor how to protect himself against such developments and outline further improvements which the inventor should work on in order to protect the extension of the inventor's ideas and the manufacturer's business.

The patent attorney should also visualize, or seek out, new lines of development, machines and processes which might grow out of the original invention, so that the inventor may be able to benefit from them as well.

He should not neglect to examine the commercial side as well. To that end he should advise on future sales campaigns and, where indicated, lay the foundation for various commercial agreements and cross-licenses for the stabilization and regulation of the industry in which the invention is to be used.

It is evident, then, that the patent lawyer, to be of most value to his client, should have much more than a sound and thorough legal training and experience. He should also be equipped with a competent and advanced scientific and engineering knowledge.

He should be well versed in economic and business trends and equipped with an underlying "sales consciousness." He should be a shrewd, far-seeing business man. And, finally, he should be blessed with a vigorous imagination.

Such a man, given proper scope, will, of course, charge more than one who can merely follow instructions and see the application through the Patent Office, but he will save, or make, the inventor or manufacturer more money in the end. And the making of money is the proper purpose of invention.

Electron Tube Applications

Moisture Control. A decalcomania moistening apparatus involving two amplifier tubes. Herbert Kott, Decal Automatic Corp., New York, N. Y. No. 2,126,784.

Sound Production. A system for the artificial production of vocal or other sounds. H. W. Dudley, BTL, Inc. No. 2,121,142.

Musical Instruction. Apparatus for assisting ensemble musical performance comprising several phonograph records, each recording one or more but not all of the tonal parts of a musical composition. R. H. Ranger, Newark, N. J. No. 2,123,258.

Coaxial Conductor Testing. Method of interrupting the paths along conductor by charge and discharge of a condenser. C. P. Bartgis, BTL, No. 2,108,637.

Lubricant Testing. Applying lubricant to a plate, vibrating plate at a predetermined frequency, and determining residue after vibration. H. C. Drake and L. J. De Lanty. Sperry Products, Inc. No. 2,108,580.

Sorting. Projection radiation on devices to be sorted, light sensitive means responsive to total radiation flux, and others responsive to spectral quality flux. E. D. Wilson, Westinghouse Electric and Manufacturing Co. No. 2,114,867.

Sound Translating Apparatus. Mechano-electric transducer actuated by the vibrations of the body due to the voice, and an electrical network for transmitting the electrical output of the transducer, the overall characteristic rising progressively with frequency from 200 to about 4000 cycles when the transducer is vibrated at constant velocity. Stuart Ballantine, Mountain Lakes, N. J. No. 2,121,778-2,121,781 and 2,122,191.

Drying Apparatus. Process for drying tobacco comprising subjecting mass of tobacco to a vacuum whereby moisture is evaporated therefrom and simultaneously creating an alternating electrostatic field in the tobacco mass

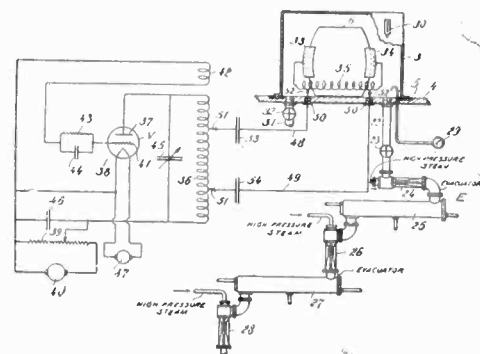

during vacuum evaporation. H. L. Smith, Jr., Thermal Engineering Corp., Richmond, Va. No. 2,124,012.

Head Lamp Tester. Apparatus for testing projection lamps comprising light-sensitive cell, etc. V. J. Roper, G. E. Co. No. 2,120,869.

Electric Sign. Electric arrangement for displaying animated pictures and communications by means of a lamp field, comprising a bank of phototubes operating control tubes which control the current through incandescent lamps. Kurt Rosenberg, assigned to the American Epok, Inc. No. 2,119,870.

Furnace Control. Apparatus for shutting off fuel supply to a furnace, etc. D. W. Fehrenbach, Kansas City Journal-Post Co. No. 2,120,053.

Exposure Meter. Meter for simultaneously determining diaphragm opening, shutter speed, and polarizer adjustment. H. Joachim, Zeiss Ikon. No. 2,117,004.

Oscillograph. Neon tube, oscillator, superposing on the r-f wave an audio wave to be examined. B. J. Haskins, and R. W. Reitherman. No. 2,062,174.

Motor Control. Restoring balance of a normally balanced system. Wm. M. Young, Taylor Instrument Co. No. 2,115,834.

MULTI-RANGE TESTERS
"PRECISION"
QUALITY TEST EQUIPMENT
AT POPULAR PRICES

Every laboratory, broadcast and recording studio, amateur, service organization, engineer and school can use these popular PRECISION low-priced multi-range testers. All units are equipped with wire wound shunts and matched multipliers of 1% accuracy and are individually calibrated against laboratory standards.

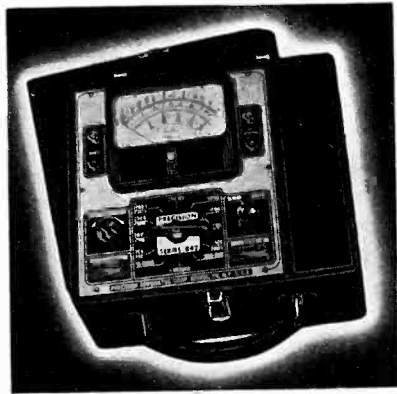

Series 842-P

- ★ Large size 4 1/4 inch square meter.
 - ★ FIVE AC and DC VOLTAGE RANGES at 1000 ohms per volt: 0 to 10/50/250/1000-/2500 volts.
 - ★ SIX DC CURRENT RANGES: 0 to 1/10/50-/250 MA: 0-1; 0-10 AMPS.
 - ★ FOUR RESISTANCE RANGES: 0-400 ohms (20 ohms center). 0-100,000 ohms. 0-1 megohm. 0-10 megohms. NOTE: Provisions for mounting ohmmeter power supply (4 1/2 and 45 v batteries) on inside of case. No external connections necessary.
 - ★ FIVE DECIBEL RANGES from -10 to +63 DB: ODB; +14DB; +28DB; +40DB; +48DB.
- 842-P Size 9x10x6. Housed in walnut finished wood portable case with removable cover. Less batteries and test leads. Net Price... \$23.95



Series 830

- ★ Five D.C. Voltage Ranges at 1000 ohms per volt: 0-10; 0-100; 0-250; 0-500; 0-1000 volts.
 - ★ Four D.C. Current Ranges: 0-1; 0-10; 0-100; 0-250MA.
 - ★ Two Resistance Ranges: Low ohms (shunt method) 1/2 to 500 ohms. High ohms 0-300,000 ohms.
 - ★ Ohmmeter Ranges are powered by self contained supply.
- Other Features:** Large 3" square meter, D'Arsonval movement 2% accuracy, adjust ohms compensator; attractive metal etched panel; walnut finished wood case with carrying strap self contained battery included; compact size 7 x 4 1/2 x 2 1/2.

Net Price.....\$10.95

SEE these as well as any of the other 12 popular PRECISION Test Equipment models on display at all the leading radio parts jobbers, or write direct to factory for latest "spec" sheets.

PRECISION
APPARATUS CO.
 821 EAST NEW YORK AVENUE
 BROOKLYN, NEW YORK

Export Div. 458 Broadway, N.Y., U.S.A. Cables: Morhanex

Time Delay. Method of preventing discharge when tube is cold. D. D. Knowles, WE&M Co. No. 2,114,883.

Oil Testing. Subjecting lubricant to a voltage gradient less than that required to produce a spark, measuring the density of the current produced and comparing with current in standard sample. A. J. McMaster, G-M Labs. No. 2,122,578.

Cardiograph. Method for amplifying and recording electrical currents. F. G. Pauly, Hellige, Inc. No. 2,124,208.

Arc Welding. Use of rectifiers for welding control. C. J. Holslag, Electric Arc Cutting and Welding Co. No. 2,132,479.

Steel Hardening. Heating a wire to its recalcence point, maintaining the temperature by rectifying a voltage secured from a reactance drop due to

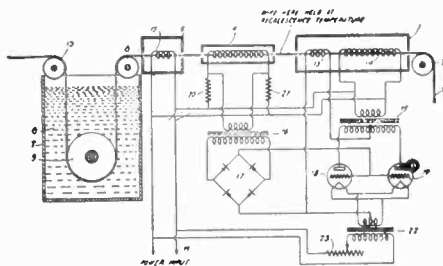

the variation in permeability of the wire. C. W. Hansell, RCA. No. 2,123,776.

Water Hardness Test. Producing an indication dependent upon hardness of water involving phototube. Eric Pick, Permutit. No. 2,122,824.

Spectrophotometer. Photoelectric device receiving light from sample and standard. O. W. Pineo, Calco Chemical Co. No. 2,197,836.

Ratio Measurement. Instrument responsive to ratio of two quantities using two tubes with parallel grid and

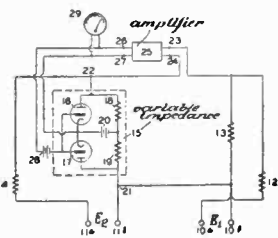

plates in series. S. A. Scherbatskoy and Jacob Neufeld, Tulsa, Okla. No. 2,129,880.

Record Machine. Phototube scanning of cards for tabulating. Waldemar Ayres, I.B.M. No. 2,131,911.

Automobile Lighting System. Approaching automobiles affect each other's lighting systems to avoid blinding. F. M. Harris, Merchantville, N. J. No. 2,131,888.

Sorting. Two patents to D. C. Cox, Electric Sorting Machine Co, Grand Rapids, Mich., on means for sorting as to color etc. Nos. 2,131,095 and 2,131,096.

WBTH
 Going
 KTSW
 up!
 CKJB
 CJKL

-all over
 the country...
LINGO
 Vertical Tubular Steel
RADIATORS



Engineers are quick to recognize a product that proves itself by performance. Lingo "Tube" Radiators have turned fiction into fact by out-performing the most exceptional verbal or written claims made for them. No wonder so many are now in use—no wonder their users are such good boosters. Write to our customers—then write to us. Just send your location, frequency and power. All recommendations and costs will be promptly quoted without obligation.

Just off the press —

"Set Your Course
 by this New Star."

Write for new illustrated folder. Contains complete details and answers to your questions about Lingo Radiators. We'd like to send you a copy right away.

LINGO
 Portable
 Dural
 Radiators

Write
 today
 for
 circular

Of extreme light-weight for emergency use. Can be erected by two men in 15 minutes. Compact, easily stored and transported. Standard lights, 40 to 100 feet.

John E. Lingo & Son, Inc.
 Dept. E-2 Camden, N. J.

LINGO
VERTICAL
TUBULAR STEEL
RADIATORS

Announcing ALL COLORS IN SPECTRUM
in *Fluorescent Materials*
FOR TELEVISION TUBES

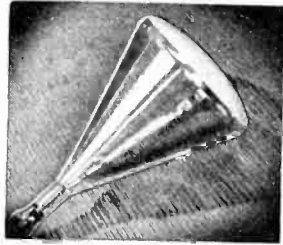

Callite Products, pioneer in FLUORESCENT MATERIALS, now has available for immediate delivery SILICATES and TUNGSTATES, in all colors in the spectrum, for Cathode Ray Television Tube applications. Callite engineers will be glad to cooperate with you in finding the proper fluorescent material for your tube design.

CALLITE LEAD-IN WIRES
OF TUNGSTEN—MOLYBDENUM—KULGRID

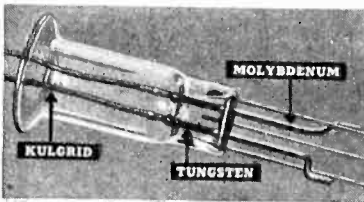

Tungsten in Callite Hard Glass Welds is processed to give compact fibrous structure free from longitudinal cracks and is centerless ground to eliminate surface imperfections.

Molybdenum supports are rigid and maintain proper alignment of tube parts. Only pure metals of best quality are used.

Accept no inferior substitutes. For more detailed information write to engineering department. Your inquiries are invited.

Kulgrid 'C' Strand does not oxidize, does not become brittle, and welds more readily to tungsten and copper.

CALLITE PRODUCTS
DIVISION

EISLER ELECTRIC CORP. • 544 39th ST. • UNION CITY, N. J.



Frequency Measuring Service



Many stations find this exact measuring service of great value for routine observation of transmitter performance and for accurately calibrating their own monitors.

MEASUREMENTS WHEN YOU NEED THEM MOST
at any hour every day in the year

R.C.A. COMMUNICATIONS, Inc.

Commercial Dept.

A RADIO CORPORATION OF AMERICA SERVICE

66 BROAD STREET

NEW YORK, N. Y.

WAXES • COMPOUNDS • VARNISHES
for **ELECTRICAL INSULATION**

Zophar offers prompt service on Insulating Compounds for a wide variety of electrical applications, including:

... insulation for CONDENSERS, TRANSFORMERS, COILS, power packs, pot heads, sockets, wiring devices, wet and dry batteries, etc. Also WAX SATURATORS for braided wire and tape. WAXES for radio parts.

Special compounds made to your order.

ZOPHAR MILLS INC.

130-26th St.

Brooklyn, N. Y.

FOUNDED 1846

Motor Control. Arc discharge tube and circuits for controlling energy to the motor. I. O. Miller, Brown & Sharp Mfg. Co. No. 2,119,715.

Workpiece Control. System for controlling machine tool equipment. Walter Fouquet, WE&MCo. No. 2,114,835.

Oscillator. Generator of sound waves for audiometric work on the human ear. Sam Snead, Otofex Corp. No. 2,119,971.

Door Opener. Responsive to differential illumination of two points. A. H. Lamb, Weston El. Inst. Corp. No. 2,096,902.

Traffic Control. Ultra high frequency system using directive transmission. W. S. Halstead, N. Y. No. 1,131,042.

Stabilizing Apparatus. Impressing a stabilizing couple on a ship, measuring angle of rolling and couple of rolling, forming time derivatives and integrals of these quantities forming a linear

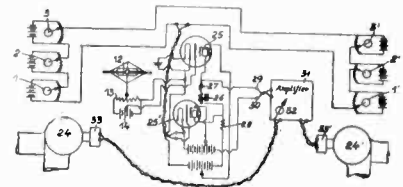

function of these quantities and using this linear function to control the ship. Y. A. Rocard, Paris. No. 2,130,929.

• • •

INEXPENSIVE FACSIMILE RECORDER



This radio facsimile receiver, said to sell for eighty dollars will pick up and scan type and pictures to produce a miniature newspaper. The Crosley name may be seen on the upper half of the cabinet.

Voltage Regulation. Patents to W. H. Howe, Cincinnati Milling Machine Co. No. 2,082,496 and 2,082,497. No. 2,118,440 to F. G. Logan, Ward Leonard Electric Co. No. 2,117,138 to C. D. Bock, New York, N. Y.

Measuring Equipment. Patents to J. D. Ryder, Bailey Meter Co. No. 2,127,845 and 2,127,846.

Musical Instrument. An electrical musical instrument comprising a frequency dividing system for supplying

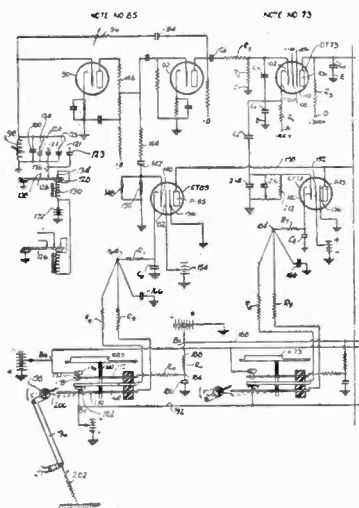

a plurality of frequencies for octave notes of the instrument. Laurens Hammond, Chicago, Ill. No. 2,126,682.

Haze Penetrator. A filter which passes infrared rays, a cathode ray tube, etc. H. E. Jones, Kansas City Testing Laboratory. No. 2,121,771.

Burglar Alarm System. An amplifier, a piezo electric crystal and enclosure in which the air is maintained at a pressure different from that on the outside. L. H. Chase and C. L. Loudon, Holmes Electric Protective Co. No. 2,129,261.

Charge Indicator. Device for indicating a charged condition of the frame of a vehicle having a power circuit comprising an indicator, an electron tube, a polarized relay connected across the power circuit, etc. L. C. Josephs and L. J. Heine, Mack Mfg. Corp. No. 2,125,050.

Recorder. A balanceable network which can be unbalanced to produce an alternating current whose phase and amplitude correspond to the sense and magnitude of a change of a condition. Leo Behr, A. J. Williams and J. V. Adams, Leeds & Northrup Co. No. 2,124,684.

Statistical Machine. Records on film are fed past a photocell for tabulation purposes. J. W. Bryce, IBM Corp. No. 2,124,906.

Measuring Instrument. A galvanometer for use in rail testing. D. C. Bettison and F. H. Keaton, Omaha, Neb. No. 2,125,983.

NEW PRESTO RECORDER ADDS SOUND TO HOME MOVIES

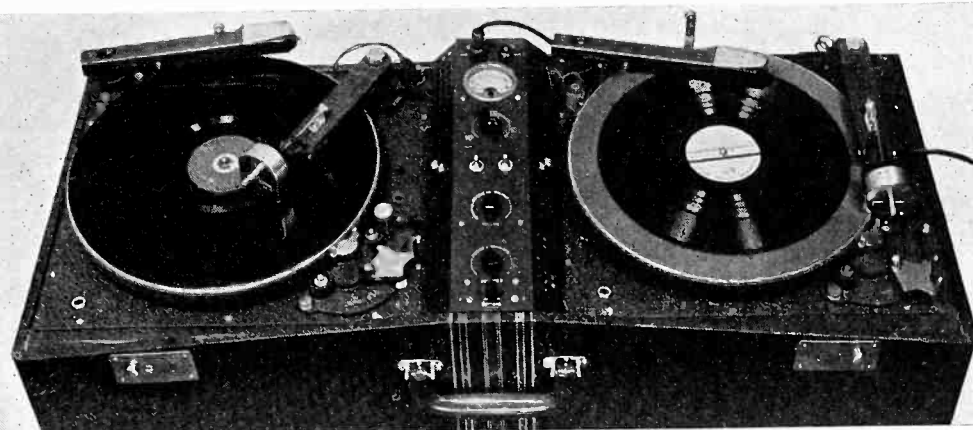

With this new Presto model M recorder you can record sound as you take your home movies—then reproduce the sound as the picture is projected. Two 12", dual speed (78 & 33 1/3 RPM) turntables enable you to record and playback records continuously, without interruption. The amplifier has a two position mixer to permit recording simultaneously from two microphones or to dub in background music and sound effects with the voice of the commentator. The entire equipment is mounted in a single carrying case which measures 10"x15"x35" and weighs 62 lbs.

Write for folder giving full description of the Presto model M recorder and its many uses.

PRESTO RECORDING CORP.
246 W. 55th St., New York, N. Y.

GOAT'S HISTORY OF SIGNIFICANT EVENTS—2

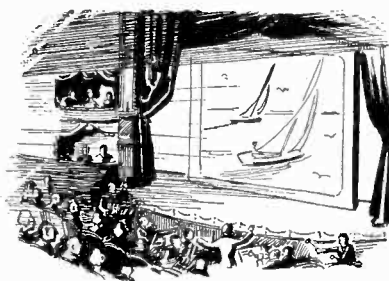

IN '94 . . .

a few people in an unbelieving world saw the first preview of a moving picture feature. From that humble beginning has grown the huge cathedrals of the modern film entertainment, as we know it today, reaching into nearly every corner of the world.

TODAY . . .

In that same year, Fred Goat, founder of the Fred Goat Company, celebrated his first business anniversary. Today, as the leading independent supplier of radio tube shields, Goat Radio Tube Parts, Inc. (a division of the Fred Goat Co.) points with pride to the compact, form fitting tube shields which have been developed in cooperation with the industry's leading engineers . . . and which are so important to improved set performance.



GOAT RADIO TUBE PARTS, INC.

(A DIVISION OF THE FRED GOAT CO., EST. 1893)

314 DEAN ST., BROOKLYN, N. Y.

Television & Radio

Electron Multiplier. Patent No. 2,117,089, on an electronic oscillator and

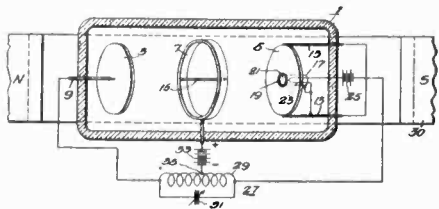

multiplier. R. R. Goodrich, RCA; No. 2,113,378 on electron multiplier to E. A. Massa, Jr., and Louis Malter, RCA; No. 2,113,264 to G. B. Banks, RCA.

Mosaic Electrode. Steps and method of preparing a photo-sensitive mosaic electrode upon a metallic plate. Max Knoll, Telefunken. No. 2,116,901.

Television System. Reissue, No. 20,700 to W. L. Carlson, RCA.

Narrow Channel System. Method of broadcasting comprising amplifying a section of the audio band to be modulated, this section comprising lower frequencies and separately amplifying the remaining part of the audio band, modulating the first-named section in a two-side band modulator and the second section in a single-side-band modulator, amplifying the modulation products to different amplitudes, and

adding the modulation products, all with the idea of broadcasting with a reduced band width. Nicolaas Koomans, The Hague, Netherlands. No. 2,110,046.

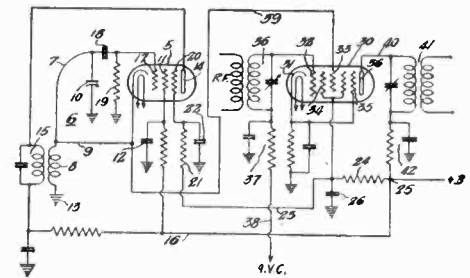

Projection Oscillograph. A high power projection device. P. T. Farnsworth and F. J. Somers, Farnsworth

Industrial Noise Analyzer

TYPE RA-273

for

Acoustic Laboratory

and

Production Testing

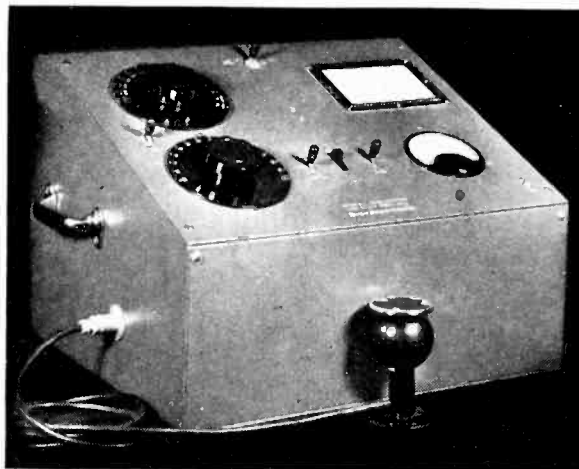

This provides the full equivalent, in a single instrument, of the RA-245 Sound Level Meter and RA-243 Filter Set, an ideal combination for loudness measurement and wide band analysis in the laboratory. Ruggedness and reliability are emphasized and controls are arranged for con-

venient routine testing in the plant.

The sound meter section is stabilized by the use of feedback amplifier and moving coil microphone. It meets all requirements of the A.S.A. standards. The filter section provides a large selection of high-pass, low-pass and octave-width band-pass characteristics.

Laboratory Acoustic Instruments
•
Production Test Equipment
•
Testing and Consulting Services

Electrical Research Products Inc.

SUBSIDIARY OF

Western Electric Company

195 BROADWAY, NEW YORK

THEREMIN PATENTS

For **SALE OUTRIGHT** or **EXCLUSIVE LICENSE** in many fields

We own and offer at a fraction of their value:

U. S. Patent No. 1,658,953 Feb. 14, 1928

U. S. Patent No. 1,661,058 Feb. 28, 1928

The Theremin patents contain many basic claims in the "Body Capacity" field. This field contains countless avenues for commercial electronic products. All fields are open for license except the Burglar Alarm Field, which has already been licensed.

To radio manufacturers, it gives the possibility, at little additional cost, of combining the "Theremin" with a radio, giving the customer not only a radio, but a musical instrument as well, that he and his family can play on.

TELETOUCH CORPORATION, 37 West 54th St., New York, N. Y.

What Good is PRECISION?



Of course, we believe with you, that precision is important. But, we say, MORE important is constancy. For, without constancy, what good is accuracy? With this in mind, Recoton uses only the finest quality, hard, tempered steel so the needle will HOLD its precision. Recoton gives the steel a high mirror polish to eliminate scratch from the recording. Recoton steel cutting needle is a finished product with precision only ONE of its MUST qualities.

RECOTON

CORPORATION
178 Prince Street N. Y. C.

PROFESSIONAL SERVICES

(Rates on Application)

ELECTRICAL TESTING LABORATORIES

Characteristics of Vacuum Tubes
Tests of photo cells, glow lamps, crater lamps.
Tests of electronic and optical devices.
East End Avenue and 79th Street
New York, N. Y.
Phone: Butterfield 8-2600

INTERNATIONAL ELECTRONICS, INC.

DESIGN AND DEVELOPMENT
Radio Television
Sound Electronics
MANUFACTURING METHODS
Condensers Tubes Resistors
Vibrators Lamps Speakers
630 Fifth Avenue New York, N. Y.
Cable: Interengin, New York

HAROLD J. McCREARY

Mem. A.I.E.E. & W.S.E.
Consulting Engineer
Laboratory Facilities
Research Electronics
Development Television
Design Radio
Factory Practice Railroad Signaling
Patent Studies Telephony
105 W. Adams St. Phone STAtE 4003 Chicago, Ill.

RADIO DEVELOPMENT & RESEARCH CORP.

CONSULTANTS AND DESIGNERS
including
Amplifiers—Antennas—Transmitters
Receivers—Laboratory Equipment
Special equipment designed and constructed
145 West 45th Street, New York, N. Y.
Tel. BRyant 9-6898

Radio & Television Engineering Service

Foreign and Domestic Services
CONSULTANTS, DESIGNERS AND MFGS. FOR
Electronic Devices—Carrier Frequency Equipment
Receivers—Amplifiers—Special Test Equipment—
Transmitter, etc.
Clifton Theatre Bldg., Main Ave., Clifton, N. J.
Phone—Passaic 2-1333

ROWE RADIO RESEARCH LABORATORY CO.

DOMESTIC SECTION
Development Engineers of Radio Receivers
Allied Apparatus and Components.
Designers and Constructors of Special Equipment.
Complete Laboratory Facilities.
1103 Bryn Mawr Ave. Chicago, Illinois
Telephones—Longbeach 3163-3164

ROWE RADIO RESEARCH LABORATORY CO.

FOREIGN SECTION
Engineering Information Specialists and
Consultants.
Complete Laboratory at Disposal of Clients.
Current Radio Receiver Characteristics Available.
Sales, Patent and License Negotiation
Intermediaries.
1103 Bryn Mawr Ave. Chicago, Illinois, U.S.A.
Cable Address—RORADLAB CHICAGO

PROFESSIONAL ASSISTANCE

In the solving of your most difficult problems in the highly specialized field of electronic devices is offered by consultants whose cards appear on this page.

Oscillator Stabilizer. A frequency converter system. J. D. Reid, RCA. No. 2,121,447.

Program Selector. An automatic time and program selector involving a time clock, switch and station selector for radio receivers. C. F. Peters, Great Kills, Staten Island, N. Y. No. 2,122,779.

Variable Selectivity Circuit. M. L. Levy, Stromberg-Carlson Tel. Mfg. Co. No. 2,122,653.

Amplifier. Two tubes connected together in the following manner: a high reactance coil is connected in shunt to the grid-cathode of the first tube and in the grid-cathode of the second tube one terminal of said reactance coil is

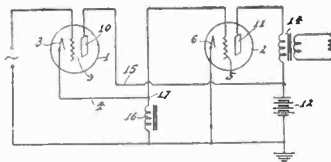

connected to the ground for maintaining the grid of the second device at or near ground potential when no signals are being transmitted. J. G. Aceves, Revelation Patents Holding Co. No. 2,113,263.

Remote Control. N. M. Rust, RCA. No. 2,114,031.

Automatic Wave Selector. No. 2,114,068 to A. W. Plensler, Belmont Radio. Filed Sept. 3, 1929. 42 claims.

Automatic Tuning Control. Patent No. 2,108,420. C. J. van Loon, Philips; No. 2,121,735-2,121,736 to D. E. Foster, RCA; 2,121,103 to S. W. Seeley, RCA; No. 2,120,974 to D. E. Foster, RCA, and No. 2,123,716 to M. G. Crosby, RCA.

British Patents

Tube Applications

Lens Testing. Testing focal length,

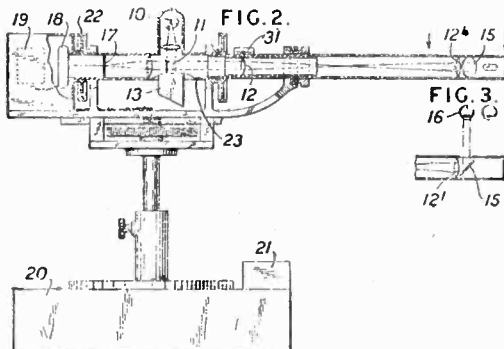

etc., of lenses and mirrors by phototube. G. Collins. No. 483,003.

Steam Testing. Transparency altering its moisture content of steam is utilized to give information regarding the moisture content. Schmidt'sche Heissdampf. No. 484,144.

SAVE

- ★ Lost program time
- ★ Expensive replacements
- ★ Initial cost
- ★ Space

WITH TYPE **174**
COMPRESSED NITROGEN
CONDENSER

WRITE FOR DESCRIPTIVE FOLDER

HEINTZ AND KAUFMAN
SOUTH CALIFORNIA LTD.
SAN FRANCISCO U. S. A.

New

MICROHM

AIR COOLED
POWER RESISTORS

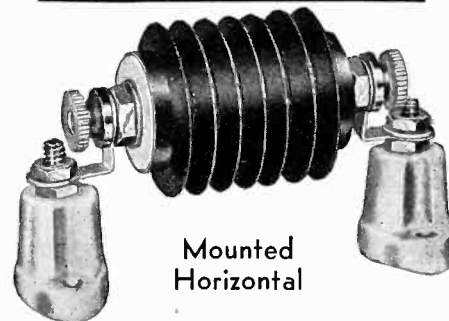

Mounted
Horizontal

NEW in principle . . . the type CA Microhm Air Cooled, Power Resistor meets the industry's demand for a power resistor that was smaller, more adaptable for various mounting arrangements, that would run cooler in smaller places, and that was unaffected by moisture and atmospheric conditions. Standard size units, 1 3/4" x 1 1/2" O.D.; both ends of the bobbin are tapped and threaded for 6/32 screws. 50 Watts (rated in free air); Accuracy 3%; resistance range 10 to 50,000 ohms.

PRECISION RESISTOR CO.

332 Badger Avenue Newark, N. J.
Manufacturers of complete line of PRECISION and INDUSTRIAL WIRE WOUND RESISTORS

Unidirectional Microphone

(Continued from page 62)

parts. A light duraluminum diaphragm e is coupled to the bimorph Rochelle salt crystal f by means of a connecting rod. One side of the diaphragm is exposed directly to the sound waves, while the other is adjacent to the enclosure g forming part of the acoustical network structure which affords communication with the rear side of the unit.

A sound wave moving in the direction indicated by the 0° arrow arrives at the front of the microphone a trifle earlier than it does at the rear because of the additional distance d which it must travel. Therefore the sound pressure P_1 leads P_2 by a phase angle

$$\phi = \omega d/c \quad (1)$$

where ϕ is the angle in radians and c is the velocity of sound.

For 180° incidence the relative phase position of P_1 and P_2 is inverted and

the latter leads the former by the same angle ϕ .

The pressure P_2 acts through the acoustical network developing a pressure P_3 in the chamber g . The net effective pressure upon the diaphragm and hence upon the crystal, is the vector difference between P_1 and P_3 . Through proper selection of constants of the acoustical network it is possible to attain a condition whereby at all important frequencies P_3 is of the same magnitude as P_2 but lags it by the angle ϕ given in Eq. (1).

The manner in which unidirectional action is attained may be shown conveniently by reference to vector diagrams of Fig. 2. Fig. 2a represents the front or 0° incidence of sound. P_1 leads P_2 by the angle ϕ , and P_3 lags P_2 by the same angle. Therefore P_1 and P_3 are displaced by an angle 2ϕ . Subtraction of P_3 from P_1 gives the resultant pressure R which acts upon the piezoelectric crystal.

Figure 2b represents the phase position of sound pressures for the rear or 180° incidence of sound. For this incidence P_1 lags P_2 by the angle ϕ , and since P_3 also lags P_2 by the same angle, P_1 and P_3 are in phase and the subtraction of the latter from the former

gives a resultant net diaphragm pressure equal to zero. The microphone will not, therefore, produce electrical output for sound waves arriving from the rear.

It has been tacitly assumed that P_1 and P_2 have the same magnitude. This assumption is valid if the wavelength of sound is several times as great as the dimensions of the instrument, which in the above microphone is true up to approximately 2500 cycles per second. At higher frequencies the described pressure relationship does not hold, but diffraction effects tend to give a relatively low sensitivity for sounds arriving from the rear. Through careful design of the external case housing the microphone unit, unidirectional action is maintained at all the important frequencies of the sound spectrum, with an average front-to-back discrimination of approximately 15 db.

Equation (1) indicates that the phase angle ϕ is proportional to frequency, and an examination of the vector diagram of Fig. 2a will show that this causes the resultant pressure upon the crystal to increase with frequency. Electrical compensation is provided in the microphone to achieve a smooth wide-range front-side response.

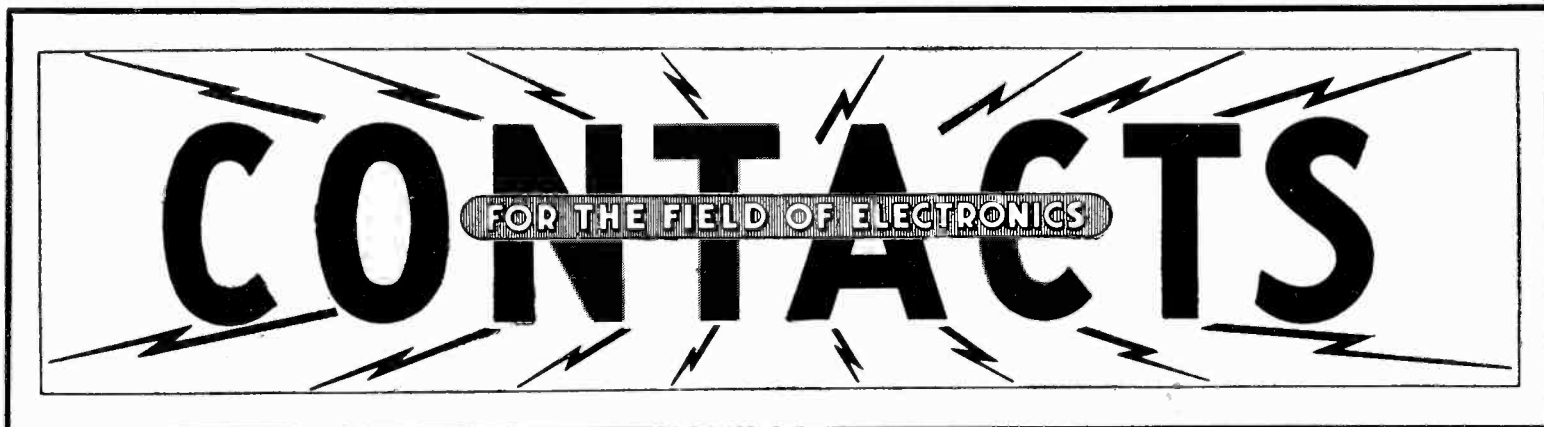

ELECTRON TUBE PARTS
 QUALITY All Types EST. 18 YEARS
 Seal Finish Tungsten Welds
 Tungar Welds Coil Springs
 Filament Hooks Bases
 Spot Welders Caps
 Stem Wire Cutting & Forming Machines
 "The Engineering Co." of Newark, N. J., Inc.
 Daniel Kondakjian, Pres.
 59 Branford Street Newark, N. J.

Write Alden Your Problem
 On every multi-wire, connector, socket problem with or without special cable. Special attention to giving you a completed cable with every consideration for it to meet every kind of requirement—mechanical, shielding, low capacitance, complicated either as to leads or covering. Also flat-woven cable with any number of leads with and without connectors. 48-hour service on leads cut to length with ends stripped, twisted and solder dipped.
ALDEN PRODUCTS COMPANY
 717 Center Street Brockton, Mass.

New Advertisements for this Section

must be received by February 27th to appear in the March issue

Address copy to the Departmental Advertising Staff
ELECTRONICS
 330 West 42 St., New York City

★ **CAESIUM AZIDE**
 ★ A Source of Purest Metal
 ★ For Research & Manufacturing
 Also other Caesium Salts and Azides of the alkaline and alkaline earth metals.
SENSITIVE PLATE & CHEMICAL CO.
 432 Clay Street San Francisco

FINE RIBBONS
 of Tungsten, Molybdenum and Special Alloys
 To your specifications
H. CROSS
 15 BEEKMAN ST. NEW YORK

Another Problem Solved
 The Insulated dial light sockets for AC DC sets that are used in nearly all the Underwriters' approved sets are Alden. Sketch your exact mounting problem and samples and prices will be forwarded promptly. All our dial light sockets have the minimum number of parts so they can be supplied to you with leads at the lowest possible over-all cost.
ALDEN PRODUCTS COMPANY
 717 Center Street Brockton, Mass.

TEN YEARS EXPERIENCE
 has no substitute in designing
Special Photoelectric Apparatus
 Indication, measurement, inspection and control for any application. Send us your problems—We offer solution and quote price. We built apparatus which will control 1000 watts from 1/1000000 lumen of light.
ELECTRONIC PRODUCTS CO.
 St. Charles, Ill.

VACUUM TUBES AND ELECTRONIC DEVICES
 Design, Development, Construction to specifications. Let us develop your idea. Geigers, magnetrons, B-Ks, tube repairs.
VACUTRON, INC.
 20 West 22 St. New York, N. Y.

We manufacture a complete line of equipment

Spot Welders, electric, from ¼ to 500 KVA
 Transformers, special and standard types
 Incandescent lamp manufacturing equipment
 Radio Tubes, ex-ray, cathode ray, photo cells
 Electronic equipment, vacuum pumps, etc.
 Tungsten slugs, rod and wire manufacturing equipment
 General glass working machines and burners
 College glass working units for students and laboratory
EISLER ENGINEERING COMPANY
 751 So. 13th St. (near Avon Ave.) Newark, New Jersey

SEARCHLIGHT SECTION

EMPLOYMENT : BUSINESS : OPPORTUNITIES : EQUIPMENT—USED or RESALE

UNDISPLAYED RATE:

10 cents a word, minimum charge 2.00.

Position Wanted, (full or part-time salaried employment only). ½ the above rates, payable in advance.

Proposals, 40 cents a line an insertion.

INFORMATION:

Box Numbers in care of our New York, Chicago, or San Francisco offices count 10 words additional in undisplayed ads. Replies forwarded without extra charge.

Discount of 10% if full payment is made in advance for four consecutive insertions of undisplayed ads (not including proposals).

DISPLAYED—RATE PER INCH:

The advertising rate is \$6.00 per inch for all advertising appearing on other than a contract basis. Contract rates quoted on request.

An advertising inch is measured ¾" vertically on one column, 3 columns—30 inches—to a page.

(New advertisements must be received by February 27 for the March issue)

POSITION VACANT

WANTED—Chief Engineer by one of industry's most successful manufacturers of dynamotors, generators and small DC motors. Excellent opportunity for the right man; substantial salary to start. All replies held strictly confidential. Give full particulars as to experience and qualifications. P-184, Electronics, 520 N. Michigan Ave., Chicago, Ill.

POSITIONS WANTED

(See also "Selling Opportunities Wanted")

ASSISTANT CHEMIST, 2 years college, broad experience in connection with the manufacturing of all types of emission and insulation coatings, also a thorough knowledge of the preparation of etching inks and lamp-black spray material. Desires position closely allied with the above experience. PW-186, Electronics, 330 W. 42nd St., New York, N. Y.

ELECTRICAL ENGINEER, college graduate, 8 years of factory engineering experience on all types of radio receiving and transmitting tubes. Thoroughly familiar with formulating all types of processing specifications, some design and development work. Lately connected with the manufacturing of all types of bamtam tubes. Desires position as factory engineer. PW-183, Electronics, 330 W. 42nd St., New York, N. Y.

COLLEGE GRADUATE in Electrical Engineering, additional study in radio engineering, holder of commercial first class radiotelephone and second class radiotelegraph licenses. Desires position in research, broadcast, design or allied fields. Age 25, eight years licensed amateur, USNR Commission. Considerable business experience. Will furnish references. PW-187, Electronics, 520 N. Michigan Ave., Chicago, Ill.

INDUSTRIAL MAINTENANCE, young man with four years experience in Signal, radio, low voltage control, lighting, small machine, and electrical installation. Can handle a responsible position. PW-188, Electronics, 520 N. Michigan Ave., Chicago, Ill.

SOUTH AMERICAN technical position desired by radio engineer. Present position as plant supervisor radio engineer. Present position as plant supervisor of NBC eastern station nine years. Thirteen years experience construction, installation and operation of radio plants. Age 32. PW-189, Electronics, 330 W. 42nd St., New York, N. Y.

DEVELOPMENT ENGINEER, European E.E. 12 years European experience. Sound film, electro-acoustics, facsimile and related fields; research, development and patent work. Also part time or consulting. PW-190, Electronics, 330 W. 42nd St., New York, N. Y.

EXECUTIVE ASSISTANT electronic research, development. Age middle thirties. Government and college training E.E. Fourteen years experience construction, test, installation H.F. equipment. PW-191, Electronics, 330 W. 42nd St., New York, N. Y.

GRADUATE Capitol Radio Engineering Institute. Age 24, thoroughly experienced in radio production and service. Have profitable ideas for production and electronic control instruments. Want position where future depends on results. PW-192, Electronics, 330 W. 42nd St., New York, N. Y.

NEON TUBE BENDER. 5 years experience glass bending and pumping. Neat work. College graduate with majors in physics and chemistry. Training in radio. Age 28. Married. Excellent references. PW-193, Electronics, 520 N. Michigan Ave., Chicago, Ill.

If it's radio, we have it!

2 completely stocked Terminal radio supply houses now serve broadcast stations, engineers and laboratories. Free delivery service. Both stores open evenings till 8:00 P.M.

Phone: VAnDerbilt 6-5050
Cable: TERMRADIO

TERMINAL Radio Corp.

2 STORES IN NEW YORK CITY
80 CORTLANDT ST. • 68 WEST 45th ST.

HIGH GRADE USED EQUIPMENT ELECTRON TUBE EQUIPMENT

Huge Stock of Equipment of Every Type and Variety

KAHLE ENGINEERING CORPORATION
Specialists in Equipment for the Manufacture of Neon Tubes, Radio Tubes, Incandescent Lamps, Photo Cells, X-ray Tubes, etc.

941 DeMott St., North Bergen, N. J.

POSITION WANTED

RADIO MAINTENANCE ENGINEER—Eleven years' experience. Desire contact with responsible company requiring services of field engineer or representative. Thoroughly familiar with installation, inspection and maintenance of radio communication and general transmitter design, and radio communication network organization. PW-194, Electronics, 330 W. 42nd St., New York, N. Y.

WANTED

ANYTHING within reason that is wanted in the field served by Electronics can be quickly located through bringing it to the attention of thousands of men whose interest is assured because this is the business paper they read.

SELLING OPPORTUNITIES OFFERED—WANTED

Selling Agencies—Sales Executives
Salesmen—Additional Lines

OPPORTUNITY WANTED

SALES ENGINEER AVAILABLE. Graduate E.E. 15 years sales and laboratory experience radio receiving and transmitting, electronic equipment with largest companies in field, would like to hear from aggressive, growing concern requiring sales development of technical equipment, and open to ideas on allied devices for new fields. SA-185, Electronics, 330 W. 42d St., New York, N. Y.



RADIO HAMS!

Are you from Missouri, Mass., N. J., W. Va., N. C., S. C., Ga., Fla., Miss., Tenn., Ark., Tex., or Mont.? If so, we have a valuable opening on our staff for the sale of shortwave diathermy units and other electro-medical apparatus.

McIntosh Electrical Corp. 223 N. Calif. Ave., Chicago



E. H. RIETZKE

PRES. OF CREI

● Radiomen . . .

Here is How-



You can step ahead into a better radio job!

You can make more money—and get ahead faster the proven CREI way

• Don't say you never had the opportunity to get ahead—for here it is! Radio wants you—and needs you—for those important jobs that new equipment and methods have created. But you must have training first. CREI courses in Practical Radio Engineering will give you the ability to qualify for a better job. Today's your chance to send for our important story.

Write Now for FREE Booklet

"A Tested Plan for a Future in Practical Radio Engineering"—IT'S FREE! Write today for your copy of this interesting, illustrated booklet! Just off the press! You'll thank us many times after you read its 48 pages.

CAPITOL RADIO ENGINEERING INSTITUTE

DEPT. E-2

3224-16th St. N.W., Wash., D. C.

DEPENDABLE

Used ELECTRONIC TUBE EQUIPMENT

A complete line of used equipment for the manufacture of Radio Tubes, Neon Tubes, Incandescent Lamps, etc.

Write for Bulletin showing savings from 25 to 75%

EISLER ELECTRIC CORP.
534 39th Street, Union City, N. J.

IF IT'S RADIO

WE HAVE IT!

We carry a tremendous stock of radio equipment for broadcast stations, engineers, laboratories and industrial companies. If you're ever in a hurry . . . just call, write or wire to



RADIO CO.

12 Fulton Street, New York, N. Y.

Cable Address: SUNRADIO NEW YORK



Yes, we're fully settled now in our new plant at New Bedford, Mass. All former Brooklyn plant equipment has been installed. Much new equipment has been added. New and additional personnel has been thoroughly trained and is working under supervision of veteran foremen and engineers.



So once again you can specify AEROVOX, with full assurance that you'll get your deliveries on TIME, in ANY QUANTITY, and of our established QUALITY.



Submit that Problem . . .
 Our engineers, remember, offer you that A.A.E.* coordinated engineering service so essential for successful assemblies. Specifications, quotations, samples, cheerfully submitted.
 *Aerovox Application Engineering



INDEX TO ADVERTISERS

Aerovox Corp.	80
Alden Products Co.	71, 78
American Automatic Electric Co.	44
American Lava Corp.	46
American Transformer Co.	57
Amperex Electronic Products, Inc.	Inside Front Cover
Astatic Microphone Laboratory, Inc.	61
Audak Company	3
Bakelite Co.	49
Biddle Co., James G.	61
Bliley Electric Corp.	68
Callite Products Division	74
Cannon Elec. Development Co.	60
Carborundum Co., Globar Div.	52
Carter Motor Co.	67
Centralab Div., Globe-Union Co.	2
Cinadagraph Corp.	58
Cinch Manufacturing Co.	45
Clare & Co., C. P.	54
Clarostat Mfg. Co.	71
Continental-Diamond Fibre Co.	48
Continental Electric Co.	67
Cornell-Dubilier Corp.	67
Cross, H.	78
Distillation Products, Inc.	54
Driver Co., Wilbur B.	65
Du Mont Laboratories, Inc., Allen B.	68
Dunn, Inc., Struthers	59
Eisler Engineering Co.	78
Eitel-McCullough, Inc.	3
Electrical Research Products, Inc.	76
Electronic Products Co.	78
Engineering Co. of Newark, N. J., The	78
Erie Resistor Corp.	41
Fairchild Aerial Camera Corp.	42
Ferranti Electric, Inc.	38
General Radio Co.	43
Goat Radio Tube Parts, Inc.	75
Guardian Electric Corp.	40
Heintz & Kaufman, Ltd.	77
International Resistance Co.	37
Jones, Howard B.	65
Lampkin Laboratories	71
Lapp Insulator Co.	5
Leach Relay Co.	68
Lingo & Son, Inc., John E.	73
Mallory & Sons, P. R.	6
McGraw-Hill Book Co.	70, 80
Ohmite Manufacturing Co.	70
Pioneer Gen-E-Motor Corp.	61
Post & Co., Frederick	69
Precision Apparatus Co.	73
Precision Resistor Co.	77
Presto Recording Corp.	75
RCA Communications, Inc.	74
RCA Manufacturing Co.	Back Cover
Recoton, Inc.	76
Richardson Co.	50
Sensitive Plate & Chemical Co.	78
Shakeproof Lock Washer Co.	Inside Back Cover
Shallcross Mfg. Co.	69
Sigma Instruments, Inc.	69
Simpson Electric Co.	59
Superior Tube Co.	53
Synthane Corp.	39
Teletouch Corp.	76
Triplett Electrical Instrument Co.	65
Vacutron, Inc.	78
Ward Leonard Electric Co.	60
Western Electric Co.	51
Weston Electrical Instrument Co.	47
White Dental Mfg. Co., S. S.	58
Zophar Mills, Inc.	74
Professional Services	77
SEARCHLIGHT SECTION	
Classified Advertising	
EDUCATIONAL COURSES	
Capitol Radio Engineering Institute	79
EMPLOYMENT	79
EQUIPMENT FOR SALE	
Eisler Electric Corp.	79
Kahle Engineering Corp.	79
Sun Radio Co.	79
Terminal Radio Corp.	79

New
 The Library now comprises a revised selection of books culled from leading McGraw-Hill publications in the radio field.

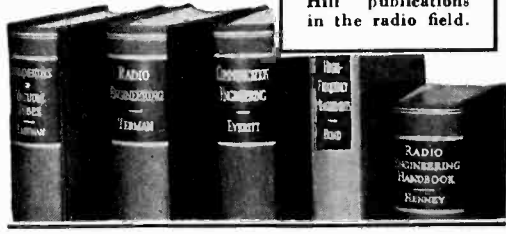

McGraw-Hill RADIO ENGINEERING LIBRARY

— especially selected by radio specialists of McGraw-Hill publications

— to give most complete, dependable coverage of facts needed by all whose fields are grounded on radio fundamentals.

— available at a special price and terms

These books cover circuit phenomena, tube theory, networks, measurements, and other subjects—give specialized treatment of all fields of practical design and application. They are books of recognized position in the literature—books you will refer to and be referred to often. If you are a researcher or experimenter—if your interest in radio is deep-set and based on a real desire to go further in this field—you want these books for the help they give in hundreds of problems throughout the whole field of radio engineering.

5 volumes 3319 pages, 2298 illustrations

1. Eastman's FUNDAMENTALS OF VACUUM TUBES
2. Terman's RADIO ENGINEERING
3. Everitt's COMMUNICATION ENGINEERING
4. Hund's HIGH-FREQUENCY MEASUREMENTS
5. Henney's RADIO ENGINEERING HANDBOOK

Special Low Price and Easy Terms

Bought singly, the five volumes comprising this library would cost you \$24.50. Under this offer you save \$2.50 and, in addition, have the privilege of paying in easy installments beginning with \$2.50, 10 days after receipt of the books, and \$3.00 monthly thereafter. Already these books are recognized as standard works that you are bound to require sooner or later. Take advantage of these convenient terms to add them to your library now.

SEND THIS ON APPROVAL COUPON

McGraw-Hill Book Co., Inc.
 330 W. 42nd St., New York, N. Y.

Send me the McGraw-Hill Radio Engineering Library 5 vols., for 10 days' examination on approval. In 10 days I will send \$2.50, plus few cents postage, and \$3.00 monthly till \$23.50 is paid, or return books post-paid. (We pay postage on orders accompanied by remittance of first installment.)

Name

Address

City and State

Position

CompanyL. 2-39

(Books sent on approval in U. S. and Canada only.)

3.00

The Single-Ended Metal Tube

ANOTHER RCA ACHIEVEMENT IN DESIGN!

There are 6 different types—all of them small—all offering advantages radio set manufacturers will appreciate!

The special construction of the 6SA7 provides excellent oscillator frequency stability. The magnitude of input capacitance of the oscillator grid is not appreciably affected by signal-grid bias. Changes in cathode current and in oscillator transconductance with AVC voltage are small.



RCA 6SK7... this is a new r-f amplifier pentode offering the same features as the 6SA7 plus more stable amplifier operation... greater uniformity of amplifier gain... and higher gain per stage. This tube not only has the same grid plate capacitance as tubes wearing grid caps, but also offers lower input and output capacitance values—plus higher transconductance. Has remote cut-off characteristic and small wafer octal, 8-pin base to fit standard octal socket.

plex-diode high-mu triode, are audio type tubes. They employ the same single-ended construction and have the same characteristic features and advantages as the r-f pentodes. Base-shielding reduces hum voltage picked up by grid lead from heater leads, permits operation with satisfactory hum level.

RCA 6SJ7... this is a new r-f amplifier pentode with the same features as the 6SK7 except that this tube has a sharp cut-off characteristic.

RCA 6SC7... a new twin triode amplifier designed primarily for phase inverter service. Hum voltage picked up by the grid lead from the heater leads is greatly reduced because of inter-lead shielding between grid and heater within the base. This permits operation with satisfactory hum level.

RCA 6SF5... a new high-mu triode... and the RCA 6SQ7... a new du-

For complete details about any of these tubes write to address below.

Here are some of the fine features of the RCA 6SA7—a new Pentagrid Converter

- Self-shielded envelope
- Complete wiring below set panel
- No grid lead to connect
- Cleaner, neater chassis
- No loose or broken grid leads
- Higher conversion gain
- Small frequency shift at high frequencies
- Economy
- Simplification of tube renewal

RCA presents the Magic Key every Sunday, 2 to 3 p. m., E. S. T., on the NBC Blue Network
Over 325 million RCA radio tubes have been purchased by radio users... in tubes, as in radio sets, it pays to go RCA All the Way



Radiotrons

A SERVICE OF THE
RADIO CORPORATION
OF AMERICA

RCA MANUFACTURING CO., INC. • HARRISON, NEW JERSEY